

**Manuale per il collegamento e l'uso - Installation and operation manual  
Manuel pour le raccordement et l'emploi - Installations-und Benutzerhandbuch  
Manual para el conexionado y el uso - Manual para la instalação e el uso**



**EN05 - EN10**

Automazioni per porte da garage  
Operator system for Garage Doors  
Opérateurs pour portes de garage  
Anleitung für einbau und bedienung  
Instrucciones de montaje y de manejo  
Instruções de montagem e manejo

## INDICE

1.	Spiegazione dei simboli	
2.	Avvisi generali per la sicurezza	1
3.	Dati tecnici EN05, EN10	2
4.	Caratteristiche del prodotto	3
4.1	Dotazione EN05, EN10	3
4.2	Varianti di porta	4
5.	Preparazione al montaggio	4
6.	Montaggio	5
6.1	Montaggio del gruppo motore della guida	5
6.2	Montaggio sulla porta	6
6.3	Montaggio a soffitto	6
6.4	Sblocco	6
6.5	Collegamenti nella centralina	7
6.6	Collegamento del lampeggiante	8
7.	Messa in funzione	8
7.1	Collegamento della ricevente e dell'alimentazione	8
7.2	Schema della centralina	8
7.3	Funzioni dei LED	9
7.4	Programmazione rapida	9
7.5	Controllo del funzionamento	12
8.	Funzioni avanzate dell'automazione	13
8.1	Prospetto generale delle funzioni avanzate di programmazione (per esempio: livello 2, menu 2)	13
8.2	Impostazione veloce delle funzioni avanzate di programmazione	14
8.3	Prospetto generale delle funzioni dei vari livelli	15
9.	Segnalazioni	18
9.1	Errori non accompagnati da segnalazioni di error	18
9.2	Errori accompagnati da segnalazioni di errore	18

## 1. Spiegazione dei simboli



### Avvertenza! Pericolo di danni alle persone!

Dopo questo simbolo seguono avvisi importanti per la sicurezza che devono essere assolutamente rispettati per evitare danni alle persone!



### Attenzione! Pericolo di danni materiali!

Dopo questo simbolo seguono avvisi importanti per la sicurezza che devono essere assolutamente rispettati per evitare danni materiali!



### Consiglio



### Controllo



### Rinvio

Le seguenti informazioni di sicurezza sono parti integranti ed essenziali del prodotto e devono essere consegnate all'utilizzatore. Leggerle attentamente in quanto forniscono importanti indicazioni riguardanti l'installazione, l'uso e la manutenzione. E' necessario conservare il presente modulo e trasmetterlo ad eventuali subentranti nell'uso dell'impianto. L'errata installazione o l'utilizzo improprio del prodotto può essere fonte di grave pericolo.

### IMPORTANTE - INFORMAZIONI DI SICUREZZA

- L'installazione deve essere eseguita da personale professionalmente competente e in osservanza della legislazione nazionale ed europea vigente.
- Dopo aver tolto l'imballaggio assicurarsi dell'integrità dell'apparecchio, in caso di dubbio rivolgersi a personale qualificato.
- I materiali d'imballaggio (cartone, sacchetti di plastica, graffe, polistirolo ecc.) devono essere smaltiti negli appositi contenitori e non devono essere dispersi nell'ambiente soprattutto non devono essere lasciati alla portata dei bambini.
- La posa in opera, i collegamenti elettrici e le regolazioni devono essere effettuati a "Regola d'arte", assicurarsi che i dati di targa siano rispondenti a quelli della rete elettrica e accertare che la sezione dei cavi di collegamento sia idonea ai carichi applicati, in caso di dubbio rivolgersi a personale qualificato.
- Non installare il prodotto in ambienti a pericolo di esplosione o disturbati da campi elettromagnetici. La presenza di gas o fumi infiammabili costituisce un grave pericolo per la sicurezza.
- Prevedere sulla rete di alimentazione una protezione per extratensioni, un interruttore/sezionatore e/o differenziale adeguati al prodotto e in conformità alle normative vigenti.
- Indicare chiaramente sul cancello, porta, serranda o barriera che sono comandati a distanza mediante apposito cartello.
- La ELVOX s.p.a. non può essere considerata responsabile per eventuali danni causati qualora vengano installati dei dispositivi e/o componenti incompatibili ai fini dell'integrità del prodotto, della sicurezza e del funzionamento.
- L'apparecchio dovrà essere destinato al solo uso per il quale è stato concepito, ogni altra applicazione è da considerarsi impropria e quindi pericolosa.
- Prima d'effettuare una qualsiasi operazione di pulizia o di manutenzione, disinserire l'apparecchio dalla rete, staccando la spina, o spegnendo l'interruttore dell'impianto. Per la riparazione o sostituzione delle parti danneggiate, dovranno essere utilizzati esclusivamente ricambi originali.
- L'installatore deve fornire tutte le informazioni relative al funzionamento, alla manutenzione e dell'utilizzo delle singole parti componenti e del sistema nella sua globalità.



### Direttiva 2002/96/CE (WEEE, RAEE).

Il simbolo del cestino barrato riportato sull'apparecchio indica che il prodotto, alla fine della propria vita utile, dovendo essere trattato separatamente dai rifiuti domestici, deve essere conferito in un centro di raccolta differenziata per apparecchiature elettriche ed elettroniche oppure riconsegnato al rivenditore al momento dell'acquisto di una nuova apparecchiatura equivalente.

L'utente è responsabile del conferimento dell'apparecchio a fine vita alle appropriate strutture di raccolta. L'adeguata raccolta differenziata per l'avvio successivo dell'apparecchio dismesso al riciclaggio, al trattamento e allo smaltimento ambientalmente compatibile contribuisce ad evitare possibili effetti negativi sull'ambiente e sulla salute e favorisce il riciclo dei materiali di cui è composto il prodotto. Per informazioni più dettagliate inerenti i sistemi di raccolta disponibili, rivolgersi al servizio locale di smaltimento rifiuti, o al negozio in cui è stato effettuato l'acquisto.

### Rischi legati alle sostanze considerate pericolose (WEEE).

Secondo la nuova Direttiva WEEE sostanze che da tempo sono utilizzate comunemente su apparecchi elettrici ed elettronici sono considerate sostanze pericolose per le persone e l'ambiente. L'adeguata raccolta differenziata per l'avvio successivo dell'apparecchio dismesso al riciclaggio, al trattamento e allo smaltimento ambientalmente compatibile contribuisce ad evitare possibili effetti negativi sull'ambiente e sulla salute e favorisce il riciclo dei materiali di cui è composto il prodotto.

## 2. Avvisi generali per la sicurezza

### Leggere attentamente queste informazioni!

Questa automazione deve essere installata e messa in funzione esclusivamente da personale specializzato e qualificato.

Per personale specializzato e qualificato si intendono persone

- con conoscenza delle norme generali e speciali di sicurezza e antinfortunistiche,
- con conoscenza delle corrette norme elettrotecniche,
- con istruzione professionale nel campo dell'uso e della manutenzione di un'adeguata attrezzatura di sicurezza,
- istruiti e sorvegliati adeguatamente da esperti elettrotecnici,
- in grado di riconoscere i pericoli potenzialmente causati dall'elettricità,
- con le conoscenze necessarie per la corretta applicazione della norma EN 12635 (requisiti di installazione e utilizzazione).

### Garanzia

Per usufruire della garanzia relativa al funzionamento e alla sicurezza dell'automazione, è indispensabile il rispetto delle disposizioni contenute in queste istruzioni. La mancata osservanza di queste avvertenze può provocare danni alle persone ed alle cose.

Il produttore non risponde dei danni provocati dalla mancata osservanza delle istruzioni.

Le batterie, i fusibili e le lampadine sono esclusi dalla garanzia.

Procedere sempre secondo le istruzioni, per evitare errori di montaggio e danni alla porta o all'automazione!

Prima della messa in funzione del prodotto è indispensabile la lettura delle istruzioni d'uso e di montaggio.

Le istruzioni d'uso e di montaggio devono essere consegnate all'utilizzatore dell'impianto.

Infatti contengono istruzioni importanti per le operazioni successive di uso, controllo e manutenzione.

Il prodotto è fabbricato secondo le direttive e norme indicate nella dichiarazione di conformità del produttore.

Il prodotto è uscito dalla fabbrica in stato perfetto dal punto di vista tecnico e della sicurezza.

Finestre, cancelli e porte automatizzate devono essere controllati da parte di un esperto (con documentazione scritta) prima della loro prima messa in servizio e anche almeno una volta l'anno, a seconda delle necessità!

### Uso convenzionale del dispositivo

Questa automazione deve essere destinata

esclusivamente all'apertura e alla chiusura di porte da garage.

Questa automazione è adatta esclusivamente all'esercizio in locali asciutti.

Osservare la forza massima di trazione e di spinta.

### Requisiti della porta

La porta deve:

- poter essere fermata in ogni punto della sua corsa (essere bene bilanciata),
- essere agevolmente manovrabile.

**Oltre alle disposizioni contenute in queste istruzioni, devono essere osservate anche le norme di sicurezza e antinfortunistiche di validità generale! Si applicano le nostre condizioni di vendita e di fornitura.**

### Avvertenze per il montaggio dell'automazione

- Assicurare che la porta si trovi in buon stato dal punto di vista meccanico.
  - Assicurare che la porta si fermi in ogni posizione.
  - Assicurarsi che il cancello sia agevolmente manovrabile in direzione di APERTURA e CHIUSURA.
  - Assicurare che la porta si apra e chiuda correttamente.
  - Rimuovere tutti i componenti non necessari (ad esempio funi, catene, angolari, ecc.).
  - Mettere fuori funzione tutti i dispositivi che non occorrono dopo il montaggio dell'automazione.
  - Prima dei lavori di cablaggio, è indispensabile separare l'automazione dall'alimentazione elettrica. Assicurare che il dispositivo rimanga separato dall'alimentazione elettrica per tutta la durata dei lavori di cablaggio.
  - Osservare le norme di sicurezza locali.
  - Installare sempre separatamente i cavi di rete ed i cavi all'elettronica. La tensione pilota è di 24 V DC.
  - Montare l'automazione solo a porta chiusa.
  - Installare tutti i trasmettitori di impulso e dispositivi di comando (ad esempio una tastiera a radiocodici) a distanza di visibilità e a distanza di sicurezza dalle parti mobili della porta. Per il montaggio occorre rispettare un'altezza minima di 1,5 metri.
  - Installare stabilmente ed in luoghi ben visibili i cartelli d'avvisocontro il pericolo di schiacciamento.
  - Assicurarsi dopo il montaggio che nessuna parte della porta sporga su strade o marciapiedi pubblici.
- Avvertenze per la messa in funzione dell'automazione. Dopo la messa in funzione, gli utilizzatori dell'impianto devono essere adeguatamente istruiti nell'uso!
- Assicurare che i bambini non possono giocare con il comando dell'automazione della porta.
  - Prima della manovra della porta assicurare che non si trovino persone o oggetti nella zona di pericolo della porta stessa.
  - Controllare tutti i dispositivi di comando d'emergenza esistenti.
  - Non mettere mai le mani nella porta o nei componenti in movimento.
  - Esaminare attentamente l'impianto per individuare gli eventuali punti a rischio di lesioni di taglio o schiacciamento.
- Osservare in ogni caso le disposizioni della norma EN 13241-1.

### Avvertenze per la manutenzione dell'automazione

Per garantire il funzionamento regolare dell'automazione, occorre verificare i punti seguenti a intervalli regolari e, all'occorrenza, provvedere alla manutenzione necessaria: Separare l'automazione dalla corrente elettrica prima di eseguire qualsiasi lavoro.

- Verificare ogni mese, se l'automazione inverte la corsa del cancello, quando questo incontra un ostacolo. Mettere a questo scopo un ostacolo di 50 mm di altezza/larghezza nel percorso che la porta deve compiere a seconda della direzione di movimento.
- Verificare l'impostazione della sicurezza antischiacciamento APERTURA e CHIUSURA.
- Verificare tutte le parti mobili della porta e dell'automazione.
- Verificare se l'impianto evidenzia eventuali danni o segni di usura.
- Verificare periodicamente se la porta è agevolmente manovrabile a mano.

### Avvertenze per la pulizia dell'automazione

Per la pulizia, non usare in nessun caso: getti d'acqua diretti, pulitori ad alta pressione, acidi o soluzioni alcaline.

### 3. Dati tecnici EN05, EN10

#### Dati elettrici

	EN05	EN10
- Tensione nominale	230 V	230 V
- Frequenza	50 Hz	50 Hz
- Assorbimento di potenza	0,7 A	0,7 A
- Assorbimento di potenza durante il funzionamento	0,2 KW	0,26 KW
- Assorbimento di potenza durante lo stand-by	< 3,9 W	< 3,9 W
- Frequenza d'uso (durata del funzionamento)	ciclo operativo breve, 2 min.	ciclo operativo breve, 2 min.
- Tensione di funzionamento	24 V DC	24 V DC
- Tipo di protezione gruppo motore	IP 20	IP 20
- Classe di protezione	II	II

#### Dati meccanici

	EN05	EN10
- Forza massima di trazione e di spinta	500 N	1000 N
- Velocità di movimento della porta	140 mm/sec.	140 mm/sec.
- Tempi di apertura (a seconda della porta)	circa 15 secondi	circa 15 secondi

#### Dati generali

	EN05	EN10
- Dimensioni del gruppo motore	160x215x395 mm	160x215x395 mm
- Peso	5,90 kg	6,70 kg
- Temperature ammesse	da -20 fino a +60 °C	da -20 fino a +60 °C

#### Dotazione

- Gruppo motore EN05 (EN10) con centralina elettronica integrata
- Antenna ricevente

#### Caratteristiche/funzioni di sicurezza

- Tecnica del punto di riferimento
- Rallentamento ai fine corsa
- Dispositivo anti-intrusione
- Dispositivo antischiacciamento
- Blocco di sicurezza
- Protezione contro le sottotensioni
- Limitazione del ciclo operativo
- Fine corsa elettronici
- Uscita predisposta per tastiere, pulsanti e selettori a chiave
- Uscita predisposta per la segnalazione dei fine corsa
- Auto-diagnostica con segnalazione degli errori.

## 4. Caratteristiche del prodotto

### 4.1 Dotazione EN05, EN10

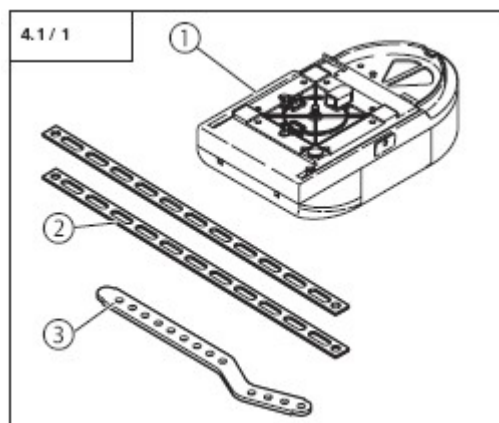

- 1- Gruppo motore EN05, EN10
- 2- Lamiera di sospensione
- 3- Staffa di trascinamento della porta

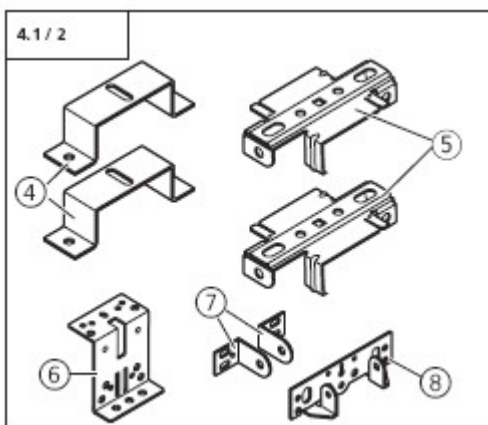

- 4- Staffe di fissaggio della guida al motore (2x)
- 5- Staffe di sospensione per la guida (2x)
- 6- Elemento di collegamento alla porta
- 7- Angolari di fissaggio (2x)
- 8- Elemento di collegamento all'architrave

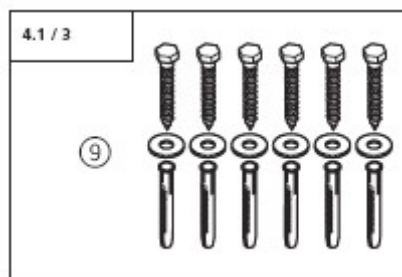

- 9- Materiale di fissaggio per la guida

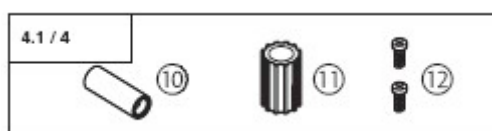

- 10- Boccola di sicurezza
- 11- Boccola adattatore
- 12- Viti 4,0 x 10 (2x)

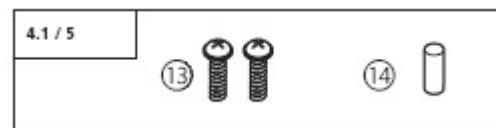

- 13- Viti 4,0 x 18 (2x)
- 14- Perno 8 x 20

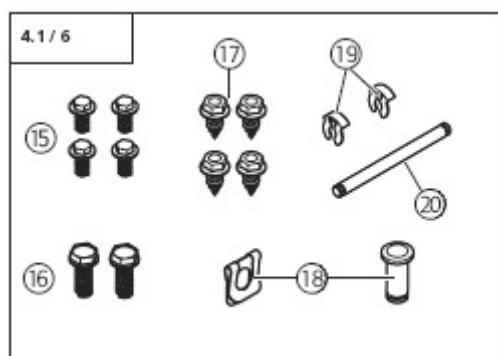

- 15- Viti 4,0 x 14 (6x)
- 16- Viti a testa esagonale M6 x 20 (2x)
- 17- Viti autofilettanti 6,3 x 16 (4x)
- 18- Perno A8 con sicura SL
- 19- Clip di sicurezza (2x)
- 20- Perno di fissaggio all'architrave  $\varnothing$  6

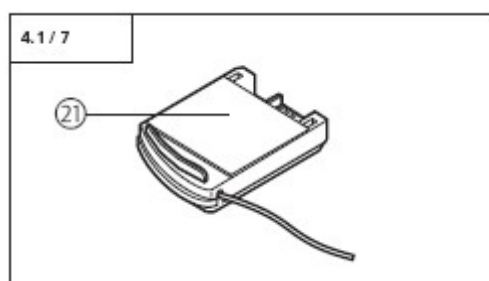

- 21- Antenna ricevente 433 MHz

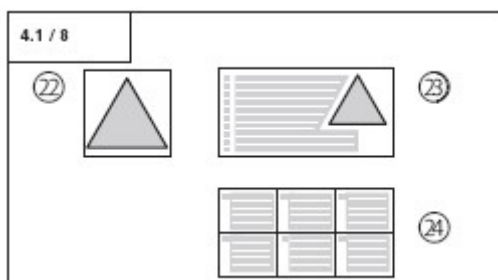

- 22 Cartellino di segnalazione per lo sblocco manuale
  - 23 Adesivo di segnalazione
  - 24 Adesivo con programmazione rapida
- Oltre alla dotazione standard, per il montaggio occorrono i seguenti accessori:
- Guida

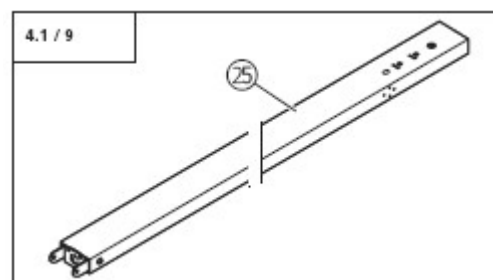

#### Guide

Il gruppo motore può essere combinato con guide diverse (vedi tabella pag. 6)

- 25- Guida

## 4.2 Varianti di porta

La dotazione standard con la guida adeguata è adatta per le seguenti varianti di porta:

### Porte basculanti debordanti (a molle)

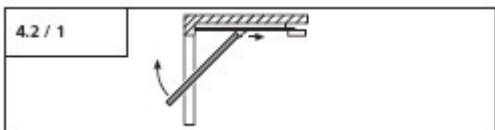

### Porte sezionali fino a 3 m di larghezza

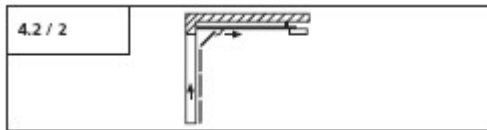

Per le seguenti varianti di porta servono accessori speciali.

### Porte basculanti non debordanti (necessita l'utilizzo del braccio curvo)



**N.B.** Nel caso di basculanti debordanti a contrappesi serve l'utilizzo del braccio curvo.

## TABELLA CON SUGGERIMENTI PER LA SCELTA DEL MODELLO DI AUTOMAZIONI A TRAINO EN05 – EN10 SU PORTE SEZIONALI RESIDENZIALI

### ATTENZIONE: PRESUPPOSTO FONDAMENTALE E' IL PERFETTO BILANCIAMENTO DELLA PORTA SEZIONALE.

L'utilizzo previsto è quello residenziale, per porte da garage di abitazioni mono- o bi-famigliari.

Nel caso in cui le porte diano accesso a un garage condominiale, uso intensivo, si consiglia l'art. EN10.

H: Altezza porta

L: Larghezza porta

Guida	H/L (mm)	2.000	2.500	3.000	3.500	4.000	4.500	5.000	5.500	6.000
<b>EN11</b>	2.250	EN05	EN05	EN05	EN05	EN05	EN10	EN10	EN10	EN10
<b>EN12</b>	2.500	EN05	EN05	EN05	EN05	EN10	EN10	EN10	EN10	EN10
<b>EN13</b>	3.250	EN05	EN05	EN05	EN10	EN10	EN10	EN10	EN10	EN10



### Attenzione!

Per garantire un'installazione regolare, devono essere effettuati assolutamente i seguenti controlli, prima di iniziare i lavori di montaggio.

## 5. Preparazione al montaggio

### Dotazione

- Verificare se la dotazione è completa di tutti i componenti.
- Verificare se sono disponibili tutti gli accessori necessari per il montaggio nella situazione specifica di installazione.

### Garage

- Verificare se il garage è provvisto di un collegamento elettrico adatto e di un salvavita.

### Porta del garage



### Attenzione!

Per garage senza ingresso alternativo: Per poter accedere al garage in caso di disturbi di funzionamento, installare uno sblocco di emergenza.

Se viene usato un kit di sblocco:

- verificare se le serrature funzionano correttamente.

Non mettere in nessun caso fuori funzione le serrature.

**Senza** uso del kit di sblocco:

- smontare le serrature o metterle fuori funzione.
- verificare se la porta da motorizzare corrisponde ai seguenti requisiti:
  - la porta può essere manovrata agevolmente a mano.
  - la porta si può fermare in ogni posizione senza che scivoli ulteriormente.



**Rinvio**

Per il collegamento di accessori, osservare le relative istruzioni fornite con gli accessori stessi.

**6. Montaggio**

**6.1 Montaggio del gruppo motore e della guida**

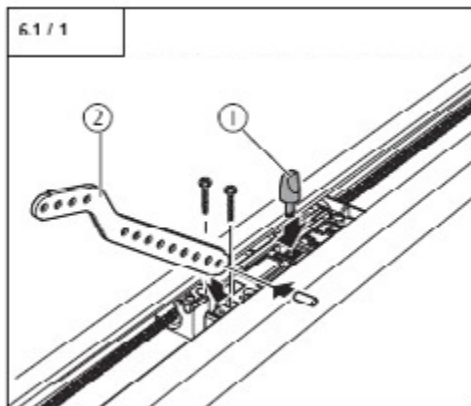

1. Inserire la spina di sblocco.
2. Montare la staffa di trascinamento della porta.

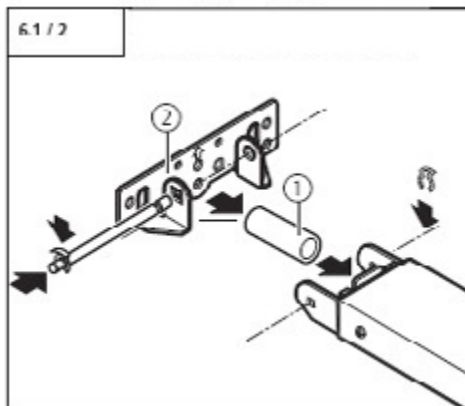

1. Inserire la boccola di sicurezza.
2. Montare la lamiera di collegamento.

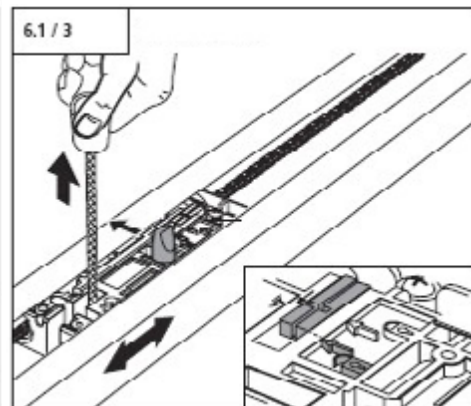

Sbloccare la slitta.

**6.1.1 Installazione standard**



**Attenzione!**

Montare la guida con cautela sul gruppo motore.  
 Non forzare mai la guida durante il montaggio, per non danneggiare l'accoppiamento guida/motore.

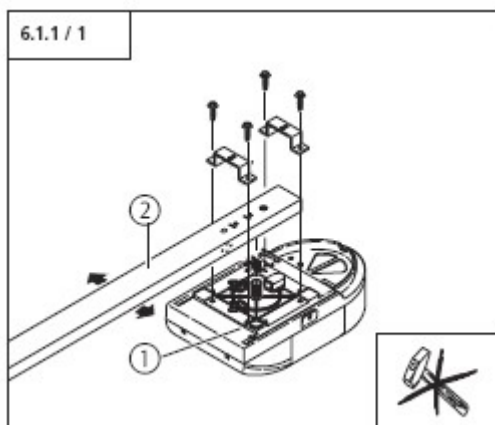

1. Inserire la boccola adattatore sull'albero di trasmissione.
2. Montare la guida sul carter del motore.

**6.1.2 Installazione trasversale**



**Attenzione!**

Montare la guida con cautela sul gruppo motore.  
 Non forzare mai la guida durante il montaggio, per non danneggiare l'accoppiamento guida/motore. Per assicurare il corretto funzionamento dell'automazione, l'interruttore del punto di riferimento (D) deve essere spostato di 90°.

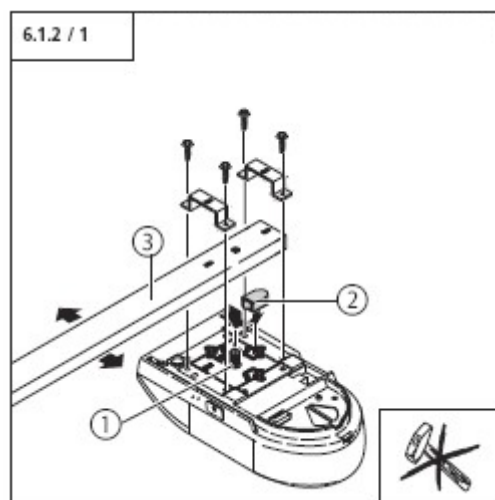

1. Inserire la boccola adattatore sull'albero di trasmissione.
2. Se necessario, spostare l'interruttore del punto di riferimento
3. Montare la guida sull'albero motore.

## 6.2 Montaggio sulla porta



### Avvertenza!

Fino al fissaggio definitivo l'automazione deve essere protetta da eventuali cadute.

### Attenzione!

Per garantire il movimento regolare della porta:

- occorre montare la guida verticalmente sulla staffa di trascinamento della porta
- il bordo superiore della porta deve essere situato in corrispondenza del punto più alto del percorso di apertura, 10 - 50 mm al di sotto del bordo inferiore orizzontale della guida.

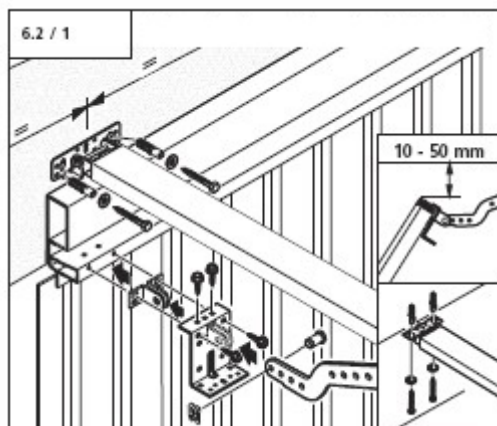

Montaggio sulla porta basculante (debordante)

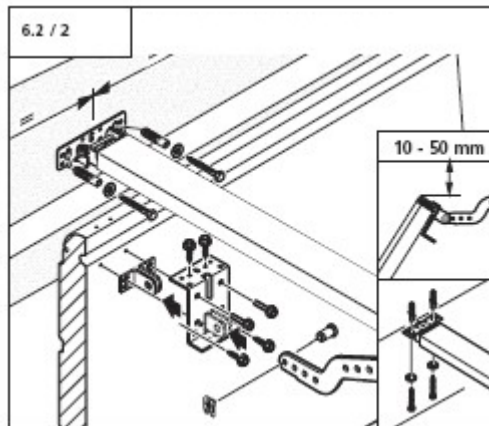

Montaggio sulla porta sezionale.

## 6.3 Montaggio a soffitto

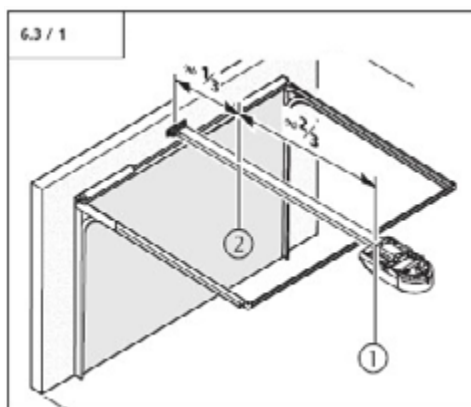

Determinare i punti di fissaggio 1 e 2

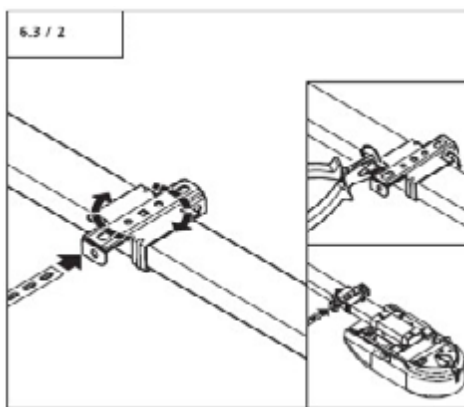

Fissare le staffe di sospensione della guida ai punti di fissaggio.

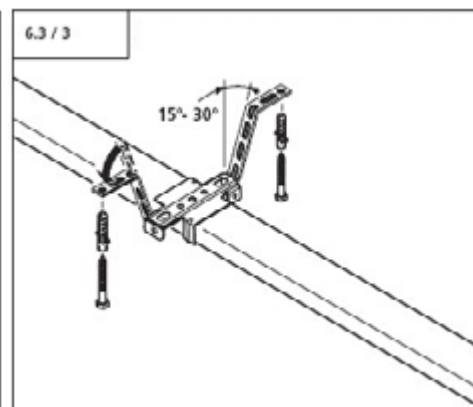

Piegare le staffe forate secondo necessità e fissarle al soffitto.

## 6.4 Sblocco



### Avvertenza!

Azionando lo sblocco rapido può succedere che la porta si muova in modo incontrollato:

- se le molle della porta sono scariche o rotte
- se la porta non è ben bilanciata.

Aperto manualmente la porta, il carello potrebbe urtare contro il gruppo motore.

Quando è sbloccata, la porta deve essere manovrata sempre a velocità moderata!

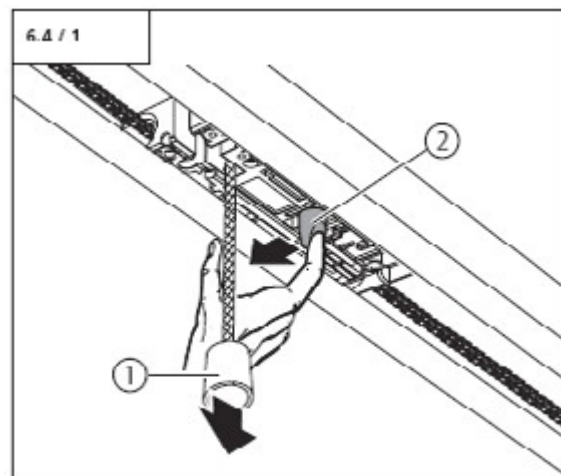

- Limitare la corsa della porta nella direzione di apertura con un fermo meccanico
- Verificare il rispetto dell'altezza minima del cordino di sblocco (1,8 m).
- Applicare l'etichetta d'avviso "sblocco" sul cordino.

1. Per sbloccare porta e gruppo motore
2. Per riagganciare porta e gruppo motore



## 6.5 Collegamenti nella centralina



### Avvertenza!

Pericolo di scosse elettriche:

prima dei lavori di cablaggio occorre assicurare che i cavi siano privi di tensione.

Durante i lavori di cablaggio occorre assicurare che i cavi rimangano privi di tensione (evitare p.es. la riaccensione).



### Attenzione!

Per evitare danni alla centralina:

- Osservare sempre le norme di sicurezza in vigore.
- Installare sempre i cavi dell'alimentazione di rete separatamente rispetto ai cavi di collegamento alle componenti elettroniche.
- La tensione di funzionamento è 24 V DC.
- L'eventuale tensione esterna sui collegamenti XP020, XB10 o XB01 causa la distruzione dell'intero sistema elettronico.
- Collegare solo contatti puliti normalmente aperti ai morsetti 1 e 2 (XB01).
- Non inserire lo spinotto a plug ponticellato nella presa XP020!

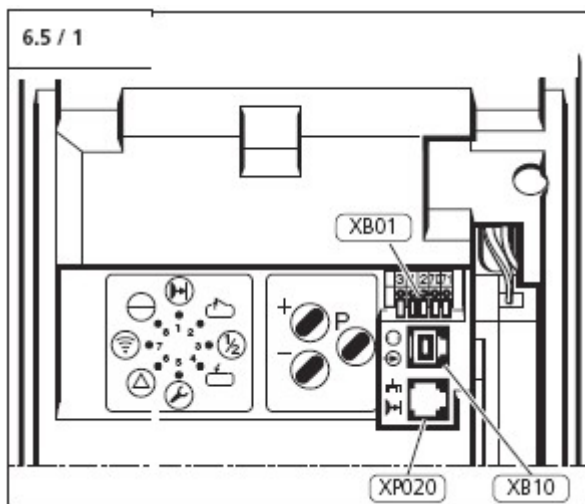

Possibilità di collegamento.

Descrizione	Tipo / Funzione	
XB01	Morsettiera per accessori esterni di comando o fotocellula con cavi tradizionali	6.5 / 2
XB10	Non utilizzato	-
XP020	Morsetto per contatto N.C. (Art. EN0C opzionale) per aggiungere un secondo comando o fotocellula.	-



### Rinvio:

Osservare le istruzioni specifiche per il montaggio degli accessori esterni di comando e dei dispositivi di sicurezza e di segnalazione.



### Consiglio:

Prima di collegare un accessorio di comando all'innesto a plug corrispondente nella centralina, occorre rimuovere dall'innesto lo spinotto a plug ponticellato.

### Collegamento XB01: si può collegare un comando esterno (selettore o pulsante) o fotocellule

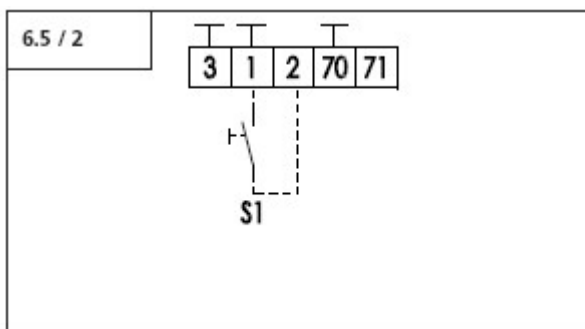

Descrizione	Tipo / Funzione	
1	Terra GND	
2	Contatto programmabile in input	8.2 / Livello 5
3	Collegamento + 24 V DC (max 50 mA)	-
70	Senza funzione	-
71	Senza funzione	-
S1	Esempio di collegamento: Pulsante esterno ad impulso passo-passo	8.2 / Livello 5

### Collegamento della fotocellula ELVOX (alimentazione 24V) alla morsettiera XB01

Descrizione	Tipo / Funzione	
1	COM, -	-
2	N.C. (contatto normalmente chiuso) N.A. (contatto normalmente aperto)	8.2 / Livello 5
3	-	-

### Rinvio:

Dopo avere collegato la fotocellula ELVOX, occorre impostare il Contatto programmabile scegliendo il parametro C1 (Stop e inversione). Questa programmazione è descritta al Paragrafo 8.2, Livello 5.

- plug **XP020**: si può avere un contatto NC aggiuntivo (opzionale), art EN0C, per ottenere l'utilizzo di un comando esterno (selettore o pulsante) e delle fotocellule (alimentazione 24V).

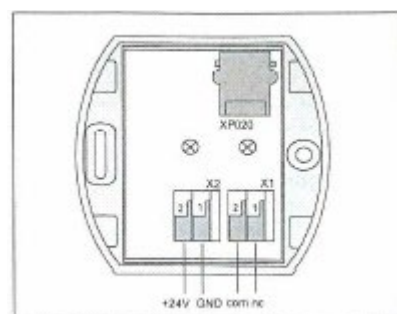

## 6.6 Collegamento del lampeggiante ELVOX Art. ELA3 (alimentazione 230V) al morsetto della luce di cortesia



### Attenzione!

Per evitare di danneggiare la guaina isolante del cavo elettrico, occorre sempre posare il cavo in modo che non sia in contatto con la lampadina della luce di cortesia.

- Rimuovere il carter della luce di cortesia.
- Collegare il lampeggiante.
- Impostare la funzione desiderata (livello 3, menu 1).
- Riposizionare il carter della luce di cortesia.

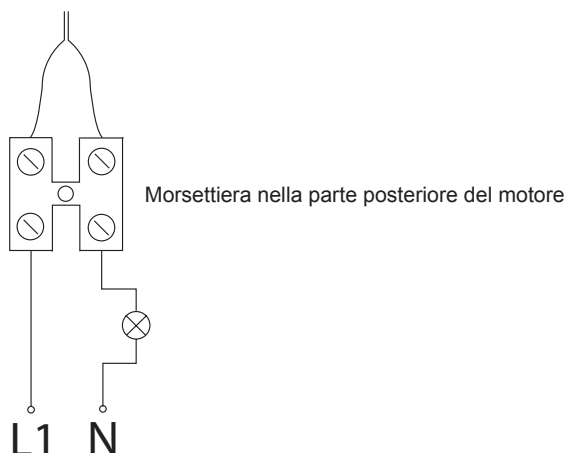

## 7. Messa in funzione

### 7.1 Collegamento della ricevente e dell'alimentazione

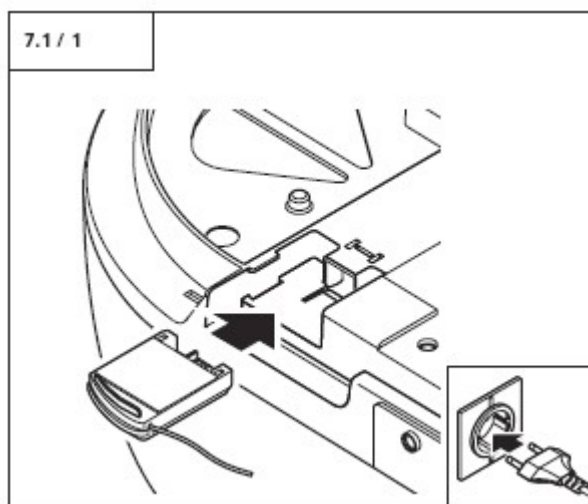

### 7.2 Schema della centralina

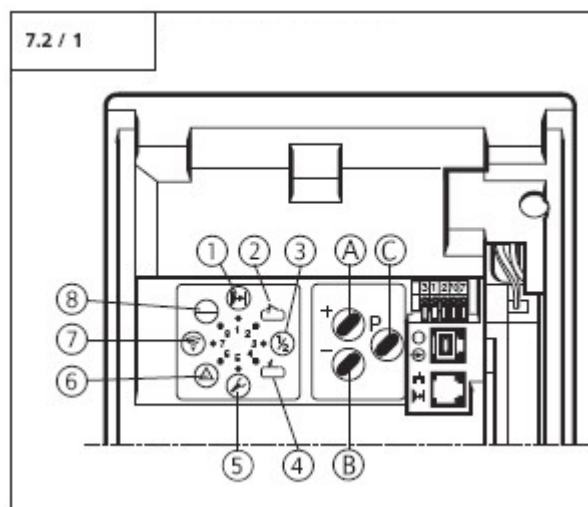

#### LED di indicazione









- 1- Fotocellula (il LED si accende quando il raggio della fotocellula è interrotto)
- 2- Fine corsa di APERTURA
- 3- Fine corsa intermedio
- 4- Fine corsa di CHIUSURA
- 5- Controllo del punto di riferimento
- 6- Senza funzione
- 7- Impulso (radiocomando, accessori esterni di comando)
- 8- Alimentazione







#### Elementi di comando esterni

- A Tasto (+) (per muovere la porta verso il fine corsa di APERTURA o per aumentare i parametri della programmazione)  
 B Tasto (-) (per muovere la porta verso il fine corsa di CHIUSURA o per diminuire i parametri della programmazione)  
 C Tasto (P) (per entrare nella modalità di programmazione o per memorizzare le modifiche dei parametri)

### 7.3 Funzioni dei LED

#### LED nella modalità di funzionamento

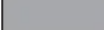
	Il raggio della fotocellula è stato interrotto
	La porta si muove in direzione di APERTURA
	Porta in fine corsa di APERTURA
	La porta si muove in direzione di CHIUSURA
	Porta in fine corsa di CHIUSURA
	Rilevamento del punto di riferimento
	Azionamento continuo di un elemento di comando
	Azionamento del radiocomando
	Alimentazione

Legenda:	
LED spento	
LED acceso	
LED lampeggia lentamente	
LED lampeggia ritmicamente	
LED lampeggia velocemente	
Impostazioni di fabbrica	
Non possibile	

### 7.4 Programmazione rapida



**Consiglio:**

Prima di far funzionare l'automazione occorre effettuare la programmazione rapida: Queste operazioni sono necessarie per la prima messa in funzione e dopo un reset.

**Prima di iniziare la programmazione rapida**

Prima di iniziare la programmazione rapida occorre che:

- la porta si trovi nel fine corsa di CHIUSURA.
- la porta non sia sbloccata manualmente.



**Consiglio:**

Durante la programmazione dei fine corsa di APERTURA e di CHIUSURA occorre passare il punto di riferimento.

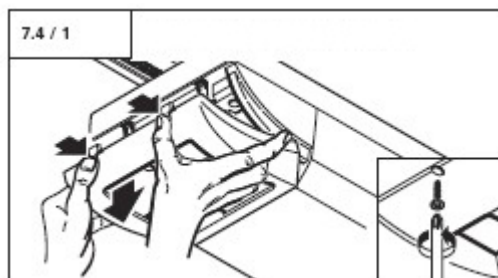

Rimuovere il carter della centralina

**La programmazione è effettuata con i tasti più (+), meno (-) e (P).**

















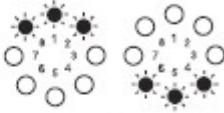



Se in modalità di programmazione non viene azionato nessun tasto entro 120 secondi, la centralina ritorna automaticamente nella modalità di funzionamento e segnala l'errore relativo alla programmazione interrotta.



**Rinvio:**

Una descrizione delle segnalazioni di errore è contenuta nel paragrafo 9.

- Effettuare la programmazione rapida secondo lo schema seguente.

 <p>Modalità di funzionamento</p>	1.	 <p>1x &gt;2s &lt;10s</p>	<p>Iniziare la programmazione rapida / Programmare il fine corsa di APERTURA</p>	
	2.		<p>Muovere la porta in direzione APERTURA</p>	
	3.		<p>Correzione del fine corsa di APERTURA della porta con i tasti (+) e (-).</p>	
	4.	 <p>1x &lt;1s</p>	<p>Memorizzare il fine corsa di APERTURA / Programmare il fine corsa di CHIUSURA della porta.</p>	
	5.		<p>Muovere la porta in direzione CHIUSURA</p>	
	6.		<p>Correzione del fine corsa di CHIUSURA della porta con i tasti (+) e (-)</p>	
	7.	 <p>1x &lt;1s</p>	<p>Memorizzare il fine corsa di CHIUSURA / Programmare il radiocomando</p>	
	8.		<p>Azionare il telecomando</p>	
	9.		<p>Rilasciare il tasto del radiocomando</p>	
	10.	 <p>1x &lt;1s</p>	<p>Memorizzare il codice del radiocomando / Terminare la programmazione rapida</p>	

**PROGRAMMAZIONE RAPIDA EN05 - EN10**

1. Con la porta in posizione di chiusura totale alimentare l'attuatore.  
 Il Led n°8, che indica la presenza di alimentazione, e il led n°4, che indica la porta chiusa, devono essere accesi ○.
  
2. Per iniziare la programmazione rapida premere il tasto P finché si accendono i tre led nella parte superiore n°8 - n°1 - n°2.
  
3. Lasciare il tasto P e premere il "+". Tenere premuto il "+" fino alla apertura totale della porta. Durante l'apertura della porta i 3 led lampeggiano. Eseguire eventuali correzioni utilizzando il tasto "-" e "+".
  
4. Premere il tasto P per memorizzare il fine corsa di Apertura.  
 Si accendono i tre led rossi nella parte inferiore, n°4 - n°5 - n°6.
  
5. Lasciare il tasto P e premere il tasto "-". Tenere premuto il "-" fino alla chiusura totale della porta. Durante la chiusura della porta i 3 led lampeggiano. Eseguire eventuali correzioni utilizzando il tasto "+" e "-".
  
6. Premere il tasto P per memorizzare il fine corsa di Chiusura.  
 Si accendono i led rossi n°6 - n°7 (lampeggiante) - n°8.
  
7. Premere il tasto del radiocomando. Il led n°7 indica la memorizzazione del codice tramite un lampeggio veloce.
  
8. Premere il tasto P per memorizzare il codice radio e tenerlo premuto per 1sec.  
 Si accendono e si spengono tutti i led in senso antiorario e l'attuatore esce dalla programmazione ritornando nella condizione iniziale (led n°8 e n°4 accesi).
  
9. Per verificare il corretto funzionamento eseguire, premendo il tasto del radiocomando, l'apertura e la chiusura della porta.

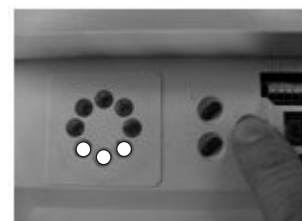
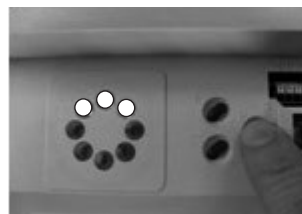
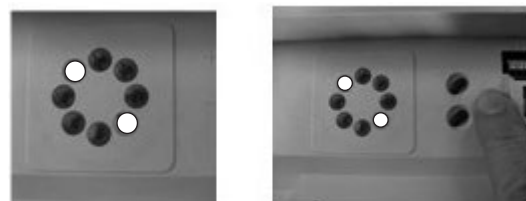

## 7.5 Controllo del funzionamento

### 7.5.1 Ciclo operativo di prova per l'autoregolazione della limitazione di coppia



#### Controllo:

Dopo la programmazione rapida e le modifiche nel menu di programmazione si devono eseguire le seguenti manovre di prova e test.

L'automazione memorizza la potenza massima necessaria durante le prime due manovre della porta dopo la regolazione dei fine corsa.

- Muovere l'automazione (con porta innestata) senza interruzione una volta dal fine corsa di CHIUSURA al fine corsa di APERTURA e viceversa.

Durante questa manovra di prova l'automazione rileva la forza di trazione e di spinta massima necessarie per muovere la porta.

#### Verifica:

1.		Dopo la pressione del tasto (+): La porta si deve aprire e raggiungere il fine corsa di APERTURA memorizzato.
2.		Dopo la pressione del tasto (-): La porta si deve chiudere e raggiungere il fine corsa di CHIUSURA memorizzato.
3.		Dopo la pressione del tasto sul radiocomando: L'automazione si deve muovere in direzione del fine corsa di APERTURA o di CHIUSURA.
4.		Dopo la pressione del tasto sul radiocomando durante il funzionamento dell'automazione: L'automazione si deve fermare.
5.		Quando si preme di nuovo il tasto, l'automazione si deve muovere nella direzione opposta.

### 7.5.2 Controllo della sicurezza antischiacciamento



#### Avvertenza!

La limitazione di coppia in direzione di CHIUSURA e di APERTURA deve essere regolata correttamente, per evitare potenziali danni a persone ed oggetti.

#### Limitazione di coppia in APERTURA

Per porte con pannelli forati (diametro della foratura > 50 mm):

- Durante il ciclo operativo di prova, applicare nel centro del bordo inferiore della porta una massa di 20 kg.

**La porta si deve fermare immediatamente.**

#### Limitazione di coppia in CHIUSURA

- Mettere sul pavimento un ostacolo con un'altezza di 50 mm.
- Muovere la porta in direzione dell'ostacolo.

La porta si deve fermare al contatto con l'ostacolo e compiere un'inversione.



#### Consiglio:

L'impostazione dei parametri non si perde, se viene a mancare la corrente. Solo con un reset vengono reinstallati le impostazioni di fabbrica della potenza dell'automazione per la manovra di APERTURA e di CHIUSURA.

## 8. Funzioni avanzate dell'automazione.

### 8.1 Prospetto generale delle funzioni avanzate di programmazione (per esempio: livello 2, menu 2)

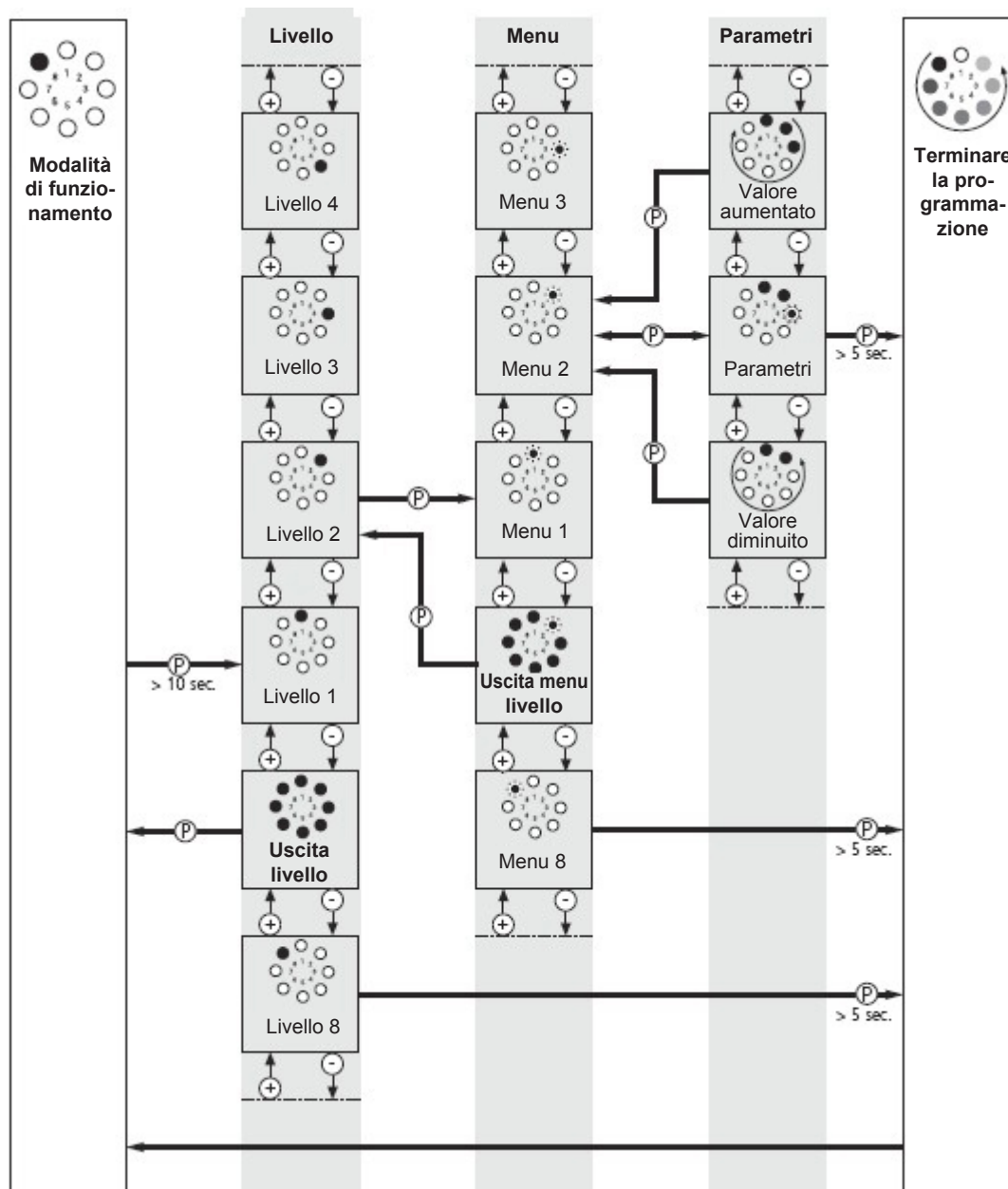

## 8.2 IMPOSTAZIONE VELOCE DELLE FUNZIONI AVANZATE DI PROGRAMMAZIONE



1. Premere il tasto (P) per un tempo > 10 sec;
2. Aspettare che si spengono tutti i led, in senso antiorario, fino ad arrivare al primo led Livello (1);

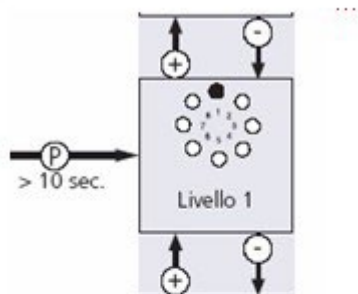

3. Lasciare il tasto (P);
4. Scegliere con i tasti (+) e (-) il livello desiderato e premere il tasto (P) per visualizzare il Menu del livello (led rosso lampeggiante);

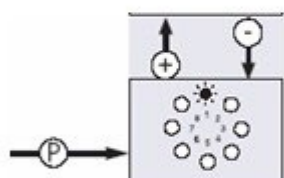

5. Con i tasti (+) e (-) scegliere il Menu desiderato;
6. Premere il tasto (P) per entrare nel Menu (led rosso lampeggia veloce);

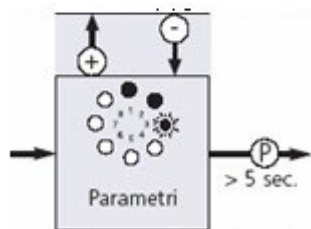

7. Premendo i tasti (+) e (-) modificare, con riferimento le tabelle riportate nelle istruzioni, le funzioni o i valori;
8. Scelto il valore desiderato premere il tasto (P) per un tempo >5sec e lasciarlo quando termina il lampeggio dei led in senso antiorario.



Terminare la programmazione

























## 8.3 Prospetto generale delle funzioni dei vari livelli



### Avvertenza!

Con le funzioni avanzate della programmazione si possono modificare parametri importanti predisposti dal produttore. I singoli parametri devono essere regolati correttamente, per evitare danni alle cose e alle persone.

Livello 1 – Impostazioni di base																
	1	2	3	4	5	6	7	8	9	10	11	12	13	14	15	16
																
<b>Menu 3: Fine corsa intermedio di APERTURA parziale</b>																
	Regolazione con i tasti + (APERTURA) e – (CHIUSURA) Dal fine corsa intermedio di APERTURA parziale è possibile attivare la richiusura automatica.															
<b>Menu 4: Fine corsa intermedio di CHIUSURA parziale</b>																
	Regolazione con i tasti + (APERTURA) e – (CHIUSURA)															
<b>Menu 5: Punto di inizio del rallentamento in APERTURA</b>																
	Regolazione con i tasti + (APERTURA) e – (CHIUSURA)															
<b>Menu 6: Punto di inizio del rallentamento in CHIUSURA</b>																
	Regolazione con i tasti + (APERTURA) e – (CHIUSURA)															
<b>Menu 7: Uscita relais programmabile</b>																
	A7	B7	C7	D7	E7	F7	G7	H7	-	-	-	-	-	-	-	-
<b>Menu 8: RESET (eseguirlo sempre con portone chiuso)</b>																
	No	Si	-	-	-	-	-	-	-	-	-	-	-	-	-	-



### Attenzione!

Il reset ripristina le impostazioni di fabbrica di tutti i parametri. Per garantire il funzionamento regolare della centralina:

- occorre programmare nuovamente tutte le funzioni desiderate,
- il radiocomando deve essere nuovamente programmato,
- si deve effettuare un ciclo operativo di prova di APERTURA e CHIUSURA complete della porta.



### Consiglio:

- Viene attivato solo l'ultimo fine corsa intermedio programmato.
- Se si attiva la richiusura automatica (livello 3 / menu 1), l'uscita relais (livello 1 / menu 7) non può essere programmata.



### Rinvio:

Dopo la modifica dei menu 3-6 del livello 1, occorre eseguire un ulteriore ciclo operativo di prova per l'autoregolazione della limitazione di coppia. Il ciclo operativo di prova è descritto nel paragrafo 7.5.1.

### Menu 7: Uscita relais programmabile

- A7- Il lampeggiante è acceso a luce fissa durante il movimento della porta
- B7- Il lampeggiante è acceso a luce intermittente durante il movimento della porta
- C7- Illuminazione di cortesia, durata 3 minuti
- D7- Impulso monostabile
- E7- Errore
- F7- Sistema di protezione anti-effrazione
- G7- Fine corsa di CHIUSURA
- H7- Fine corsa di APERTURA

Livello 2 – Impostazioni dell'automazione																
	1	2	3	4	5	6	7	8	9	10	11	12	13	14	15	16
<b>Menu 1: Potenza necessaria in APERTURA (*)</b>																
	1	2	3	4	5	6	7	8	9	10	11	12	13	14	15	16
<b>Menu 2: Potenza necessaria in CHIUSURA (*)</b>																
	1	2	3	4	5	6	7	8	9	10	11	12	13	14	15	16
<b>Menu 3: Limitazione di coppia in APERTURA (**)</b>																
	Disattivata	2	3	4	5	6	7	8	9	10	11	12	13	14	15	16
<b>Menu 4: Limitazione di coppia in CHIUSURA (**)</b>																
	Disattivata	2	3	4	5	6	7	8	9	10	11	12	13	14	15	16
<b>Menu 5: Velocità in APERTURA</b>																
	1	2	3	4	5	6	7	8	9	10	11	12	13	14	15	16
<b>Menu 6: Velocità in CHIUSURA</b>																
	1	2	3	4	5	6	7	8	9	10	11	12	13	14	15	16
<b>Menu 7: Velocità del rallentamento in APERTURA</b>																
	1	2	3	4	5	6	7	8	9	10	11	12	13	14	15	16
<b>Menu 8: Velocità del rallentamento in CHIUSURA</b>																
	1	2	3	4	5	6	7	8	9	10	11	12	13	14	15	16

\* più LED sono accesi, maggiore è la potenza applicata dall'automazione

\*\* più LED sono accesi, minore è la sensibilità della limitazione di coppia



#### Avvertenza!

Per evitare potenziali danni a persone ed oggetti, la disattivazione della limitazione di coppia (menu 3 e 4) dovrebbe essere effettuata solo in presenza di una sicurezza con auto-test collegata ed abilitata, ad esempio una fotocosta Optosensor oppure una fotocellula Special.



#### Rinvio:

Dopo avere modificato i parametri dei menu 5, 6, 7 e 8 del livello 2, occorre eseguire un nuovo ciclo operativo di prova per l'autoregolazione della limitazione di coppia. Il ciclo operativo di prova è descritto nel paragrafo 7.5.1.

Livello 3 - Richiusura automatica																
	1	2	3	4	5	6	7	8	9	10	11	12	13	14	15	16
<b>Menu 1: Richiusura automatica (impostazione standard)</b>																
	A1	B1	C1	D1	E1	F1	G1	H1	I1	-	-	-	-	-	-	-
<b>Menu 3: Intervallo di apertura della porta (in secondi)</b>																
	2	5	10	15	20	25	30	35	40	50	80	100	120	150	180	255
<b>Menu 4: Preallarme (in secondi)</b>																
	1	2	5	10	15	20	25	30	35	40	45	50	55	60	65	70
<b>Menu 5: Avviso di avviamento (in secondi)</b>																
	0	1	2	3	4	5	6	7	-	-	-	-	-	-	-	-

#### Consiglio:

- La richiusura automatica può essere programmata soltanto dopo avere abilitato una fotocellula oppure una fotocosta.
- I parametri standard programmati nel menu 1 possono essere variati singolarmente con i menu 3, 4 e 5.

**Menu 1: Richiusura automatica (impostazione standard)**

	Intervallo di apertura della porta	Preallarme	Lampeggiante	Altre funzioni
A1	-	-	-	Richiusura automatica disattivata
B1	15	5	Intermittente	-
C1	30	5	Intermittente	-
D1	15	5	Intermittente	Chiusura anticipata al passaggio della fotocellula
E1	30	5	Intermittente	Chiusura anticipata al passaggio della fotocellula
F1	15	5	a luce fissa	-
G1	30	5	a luce fissa	-
H1	15	5	a luce fissa	Chiusura anticipata al passaggio della fotocellula
I1	30	5	a luce fissa	Chiusura anticipata al passaggio della fotocellula

**Livello 4 – Programmazione del radiocomando**

















**Menu 1: Impulso passo-passo**

Il LED 7 lampeggia lentamente -> Premere il tasto del radiocomando -> Il LED 7 lampeggia velocemente

**Menu 2: Fine corsa intermedio**

Il LED 7 lampeggia lentamente -> Premere il tasto del radiocomando -> Il LED 7 lampeggia velocemente

**Livello 5 – Funzioni speciali**

	1	2	3	4	5	6	7	8	9	10	11	12	13	14	15	16
																

**Menu 1: Contatto programmabile in input (morsetti 1/2)**

A1	B1	C1	D1	E1	-	-	-	-	-	-	-	-	-	-	-
----	----	----	----	----	---	---	---	---	---	---	---	---	---	---	---

**Menu 4: Luce di cortesia (in secondi)**

	5	10	15	20	25	30	35	40	50	80	100	120	150	180	255
--	---	----	----	----	----	----	----	----	----	----	-----	-----	-----	-----	-----

**Menu 1: Contatto programmabile in input – morsetti 1/2**

A1 Impulso passo-passo (solo contatto normalmente aperto)

















B1 Interruzione della richiusura automatica (solo contatto normalmente aperto)

C1 Stop e inversione (solo durante il movimento di CHIUSURA – solo contatto normalmente chiuso / per abilitare la fotocellula Elvox)

D1 Impulso di APERTURA (spira magnetica – solo contatto normalmente aperto)

E1 Stop (solo contatto normalmente chiuso)

**Livello 8 – Impostazioni di sistema**

	1	2	3	4	5	6	7	8	9	10	11	12	13	14	15	16
																

**Menu 1: Fotocellula**

A1	B1			-	-	-	-	-	-	-	-	-	-	-	-
----	----	--	--	---	---	---	---	---	---	---	---	---	---	---	---

**Menu 1: Fotocellula (solo versioni con auto-test)**







A1 Funzionamento senza fotocellula

B1 Funzionamento con fotocellula con spinotti a plug (innesto XP020)







## 9. Segnalazioni





### 9.1 Errori non accompagnati da segnalazioni di errore







Errore	Causa	Eliminazione dell'errore
Il LED 8 non è acceso.	- Manca la tensione.	- Controllare se la tensione di rete è presente. - Controllare il collegamento alla rete elettrica.
	- La termoprotezione nel trasformatore ha reagito.	- Lasciare raffreddare il trasformatore.
	- La centralina è guasta.	- Fare controllare l'automazione.
Nessuna reazione dopo aver dato un impulso.	- Il morsetto di collegamento per il tasto "impulso" è ponticellato, p.es. tramite cortocircuito del cavo o collegamento errato.	- Provare a separare i selettori a chiave o i pulsanti interni dalla centralina (paragrafo 6.5): togliere il cavo dalla presa XB10, inserire il ponte cortocircuito e cercare l'errore di cablaggio.
Il LED 8 non è acceso.	- L'antenna ricevente non è collegata.	- Collegare l'antenna ricevente con la centralina (paragrafo 7.1).
	- La codifica del radiocomando non corrisponde alla codifica dell'antenna ricevente.	- Riattivare il radiocomando (paragrafo 7.4).
	- La batteria del radiocomando è consumata.	- Inserire una batteria nuova.
	- Il radiocomando o l'elettronica della centralina o l'antenna ricevente sono difettosi.	- Far controllare tutti e tre i componenti.

Legenda:	
LED spento	
LED acceso	
LED lampeggia lentamente	
LED lampeggia ritmicamente	
LED lampeggia velocemente	
Impostazioni di fabbrica	
Non possibile	-

### 9.2 Errori accompagnati da segnalazioni di errore

Errore	Causa	Eliminazione dell'errore
Errore 7 	- Dopo 120 secondi senza azionamento di tasti, il modo di programmazione è terminato automaticamente. - Programmazione dei fine corsa di APERTURA e CHIUSURA senza passaggio del punto di riferimento.	
Errore 8 	- L'interruttore del punto di riferimento è difettoso.	- Far controllare l'automazione.
Errore 9 	- Non vengono rilevati gli impulsi dal sensore del numero di giri, l'automazione è bloccata.	- Far controllare l'automazione.
Errore 10 	- Corsa della porta non agevole. - Porta bloccata.	- Rendere funzionante la porta.
	- La potenza massima dell'automazione è regolata ad un valore troppo basso.	- Far controllare la potenza massima dell'automazione (paragrafo 8.2 / livello 2 / menu 1 + 2) da parte di un tecnico del vostro commerciante specializzato.
Errore 11 	- Limitazione del ciclo di manovra.	- Far controllare l'automazione.
Errore 15 	- La fotocellula esterna è guasta o interrotta.	- Rimuovere l'ostacolo o controllare la fotocellula.
	- La fotocellula è stata programmata, ma non collegata.	- Disattivare o collegare la fotocellula.
	- Il sensore della corrente per la sicurezza antischacciamento è guasto.	- Far controllare il gruppo motore.

Errore	Causa	Eliminazione dell'errore
Errore 26 	- Potenza insufficiente, se la potenza massima è già regolata al livello 16 l'automazione è sottodimensionata.	- Far controllare l'alimentazione esterna della tensione.
Errore 28 	- Corsa della porta non agevole o irregolare. - Porta bloccata.	- Far controllare l'alimentazione esterna della tensione.
	- La sicurezza antischiacciamento è regolata ad un valore troppo sensibile.	- Far controllare la sicurezza antischiacciamento (paragrafo 8.2 / livello 2 / menu 3 + 4) da parte di un tecnico del vostro commerciante specializzato.
Errore 35 	- Il sistema elettronico è difettoso.	- Far controllare l'automazione.
Errore 36 	- Il ponte cortocircuito è stato rimosso, ma non è stato collegato il pulsante d'arresto. - Il circuito di riposo è stato interrotto.	- Collegare il tasto di arresto o inserire il ponte di cortocircuito (paragrafo 6.5).

Legenda:	
LED spento	
LED acceso	
LED lampeggia lentamente	
LED lampeggia ritmicamente	
LED lampeggia velocemente	
Impostazioni di fabbrica	
Non possibile	-

**Table of contents**

1.	Meaning of symbols.....	20
2.	General safety advice.....	21
3.	Technical data for EN05, EN10.....	22
4.	Product overview.....	23
4.1	EN05, EN10 supply package.....	23
4.2	Door variations.....	24
5.	Preparation for mounting.....	24
6.	Installation.....	25
6.1	Installing the motor unit and drive boom.....	25
6.2	Mounting to the door.....	26
6.3	Mounting on the ceiling.....	26
6.4	Release.....	26
6.5	Connection of control elements.....	27
6.6	Connection of ELVOX flashing light type ELA3 (supply voltage 230V) to courtesy light terminal.....	28
7.	Initial operation.....	28
7.1	Connecting the operator system.....	28
7.2	Overview of the control unit.....	28
7.3	Overview of the display functions.....	29
7.4	Express programming.....	29
7.5	Function test.....	32
8.	Extended operator functions.....	33
8.1	Programming structure for extended operator functions (Example for Level 2, Menu 2).....	33
8.2	Quick setting of advanced programming functions.....	34
8.3	Functions overview for the levels.....	35
9.	Messages.....	38
9.1	Malfunctions without error messages.....	38
9.2	Malfunctions with error messages.....	38

**1. Meaning of symbols**

**Advice**

 **Caution!**  
**Danger of personal injury!**  
The following safety advice must be observed at all times so as to avoid personal injury!

 **Attention!**  
**Danger of material damage!**  
The following safety advice must be observed at all times so as to avoid material damage!

 **Advice / Tip**

 **Check**

 **Reference**

The following security information is integrant and essential part of the product and must be given to the user. Read it carefully as it gives important suggestions concerning the installation, the use and the maintenance. Keep the present manual in order to be able to transmit it to possible future users of the installation. The erroneous installation or an improper use of the product may cause great danger.

**IMPORTANT - SECURITY INFORMATION**

- The installation must be carried out by professional technicians and according to the national and european safety regulations in force.
- After removing the packing check the integrity of the appliance. If in doubt contact qualified personnel.
- The packaging (carton, plastic bags, clips, polystyrene etc.) must be disposed of properly in the appropriate containers. It must not be left within the reach of children.
- The installation, the electrical connections and the adjustments must be carried out perfectly; check that the data on the specification plate correspond to those of the mains supply and that the connection cable cross-section is suitable for the applied loads, in case of doubt contact qualified personnel.
- Do not install the appliance in premises with danger of explosion or disturbed by magnetic fields. The presence of gasses or inflammable fumes is a great danger for the safety.
- A proper protection against extratensions should be install on the supply voltage network, i.e. a switch/sectioner and/or differential suitable for the product and according to the regulations in force.
- The gate, door, rolling shutter or barrier should bear a plate indicating that they are remotly controlled.
- ELVOX S.p.A. will not accept liability for any damage caused by the incorrect installation of devices and/or components not suitable for the integrity, the safety and the operation of the unit.
- The product must only be used for the purposes for which it was designed. Any other use is incorrect and hence dangerous.
- Before carrying out any cleaning or maintenance work, disconnect the unit from the mains supply, either by unplugging the power cord or by switching off the mains supply.
- Any repair work or replacement of damaged parts must be carried out by qualified personnel using original parts and components.
- The installer must supply all the information concerning the operation, the maintenance and the use of the single components and the whole system.

 **Directive 2002/96/EC (WEEE)**  
The crossed-out wheelie bin symbol marked on the product indicates that at the end of its useful life, the product must be handled separately from household refuse and must therefore be assigned to a differentiated collection centre for electrical and electronic equipment or returned to the dealer upon purchase of a new, equivalent item of equipment.

The user is responsible for assigning the equipment, at the end of its life, to the appropriate collection facilities. Suitable differentiated collection, for the purpose of subsequent recycling of decommissioned equipment and environmentally compatible treatment and disposal, helps prevent potential negative effects on health and the environment and promotes the recycling of the materials of which the product is made. For further details regarding the collection systems available, contact your local waste disposal service or the shop from which the equipment was purchased.

**Risks connected to substances considered as dangerous (WEEE).**

According to the WEEE Directive, substances since long usually used on electric and electronic appliances are considered dangerous for people and the environment. The adequate differentiated collection for the subsequent dispatch of the appliance for the recycling, treatment and dismantling (compatible with the environment) help to avoid possible negative effects on the environment and health and promote the recycling of material with which the product is compound.

## 2. General safety advice

### Please read carefully!

#### Target group

This operator system may only be installed, connected and put into operation by qualified and trained professionals!

Qualified and trained specialist personnel are persons

- who have knowledge of the general and special safety regulations,
- who have knowledge of the relevant electro-technical regulations,
- with training in the use and maintenance of suitable safety equipment,
- who are sufficiently trained and supervised by qualified electricians,
- who are able to recognise the particular hazards involved when working with electricity,
- with knowledge regarding applications of the EN 12635 standard (installation and usage requirements).

#### Warranty

For an operations and safety warranty, the advice in this instruction manual has to be observed. Disregarding these warnings may lead to personal injury or material damage. If this advice is disregarded, the manufacturer will not be liable for damages that might occur.

Batteries, fuses and bulbs are excluded from warranty. To avoid installation errors and damage to the door and operator system, it is imperative that the installation instructions are followed.

The system may only be used after thoroughly reading the respective mounting and installation instructions.

The installation and operating instructions are to be given to the door system user, who must keep them safe.

They contain important advice for operation, checks and maintenance. This item is produced according to the directives and standards

mentioned in the Manufacturer's Declaration and in the Declaration of Conformity. The product has left the factory in perfect condition

with regard to safety. Power-operated windows, doors and gates must be checked by an expert (and this must be documented) before they are put into operation and thereafter as required, but at least once a year.

#### Correct use

The operator system is designed exclusively for opening and closing garage doors.

The operator must be used in a dry place.

The maximum push and pull force must be observed.

#### Door requirements

The door must:

- stand still alone (by balance of springs),
- run smoothly.

Beside the advice in these instructions, please observe the general safety and accident prevention regulations!

#### Our sales and supply terms and conditions are effective.

#### Information on installing the operator system

- Ensure that the door is in good mechanical condition.
- Ensure that the door can stop in any position.
- Ensure that the door can be easily moved in the OPEN and CLOSE directions.
- Ensure that the door opens and closes properly.
- Remove all unnecessary components from the door (e.g. cables, chains, brackets).
- Render any installations inoperable that will no longer be needed after the operator system has been installed.
- Before commencing cabling works it is very important to disconnect the operator system from the electricity supply. Ensure that the electricity supply remains disconnected throughout the cabling works.
- Adhere to the local protection regulations.
- Lay the electricity supply cables and control cables; these MUST be laid separately. The controls voltage is 24 V DC.
- Install the operator system with the door in the CLOSED position.
- Install all the impulse transmitters and control devices (e.g. remote control buttons) within sight of the door and at a safe distance from the moving parts of the door. A minimum installation height of 1.5 m must be observed.
- Permanently fix the warning signs, which advise of the danger of becoming trapped, at conspicuous locations.
- Ensure that no part of the door extends across public footways or roads when the installation is complete.

#### Information on commissioning the operator system

After initial operation, the persons responsible for operating the door system, or their representatives must be familiarised with the use of the system.

- Make sure that children cannot access the door control unit.
- Before moving the door, make sure that there are neither persons nor objects in the operating range of the door.
- Test all existing emergency command devices.
- Never insert your hands into a running door or moving parts.
- Pay attention to any parts of the gate system that could cause crushing or shearing damage or accidents.

The EN 13241-1 regulations must be observed.

#### Information on servicing the operator system

To ensure proper operation, the following items must be checked regularly and repaired if necessary.

Before any works to the door system are undertaken, the operator system must be disconnected from the mains.

- Check once a month to ensure that the operator system reverses if the door encounters an obstacle. Depending on the operational direction of the door, place a 50 mm high/wide obstacle in its path.
- Check the settings of the OPEN and CLOSE automatic cut-out function.
- Check all movable parts of the door and operator system.
- Check the door system for signs of wear or damage.
- Check whether the door can be easily moved by hand.

#### Information on cleaning the operator system

Never use water jets, high pressure cleaners, acids or bases for cleaning.

### 3. Technical Data

#### Electrical data

- Nominal voltage
- Nominal frequency
- Power consumption
- Power input - operation
- Power input - stand-by
- Operating mode (operating time)
- Control voltage
- Protection category, motor unit
- Protection class

#### EN05

230 V  
50 Hz  
0.7 A  
0.2 KW  
< 3.9 W  
2 Min.  
24 V DC  
IP 20  
II

#### EN10

230 V  
50 Hz  
0.7 A  
0.2 KW  
< 3.9 W  
2 Min.  
24 V DC  
IP 20  
II

#### Mechanical data

- Max. push and pull force
- Travel speed
- Opening time (door specific) approx.

500 N  
140 mm/sec.  
15 sec.

1000 N  
140 mm/sec.  
15 sec.

#### General data

- Motor unit dimensions
- Weight
- Temperature range

160x215x395 mm  
5.90 kg  
-20 to +60 °C

160x215x395 mm  
6.70 kg  
-20 to +60 °C

#### Supply package

- Motor unit, EN05, EN10 with integrated electronic controls
- Modular antenna

#### Features / Safety functions

- Reference point technology
- Soft-Start / Soft-Stop
- Delay safety device
- Automatic cut-out
- Blocking protection
- Undervoltage protection
- Excess travel stop
- Electronic travel cut-out
- Connection for pushbuttons, code buttons and key switches
- Connection of potential-free limit switch message system
- Error messages



## 4. Product overview

### 4.1 EN05, EN10 supply package

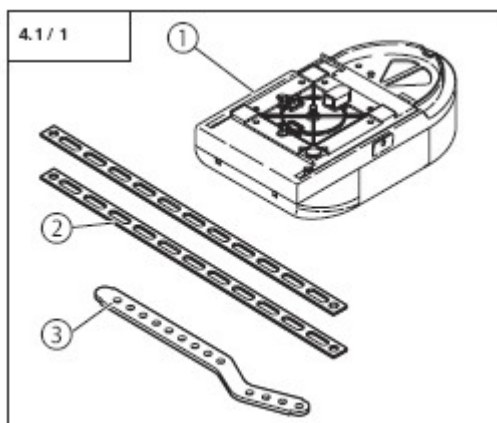

- 1- EN05, EN10 motor unit
- 2- Support plate
- 3- Door link

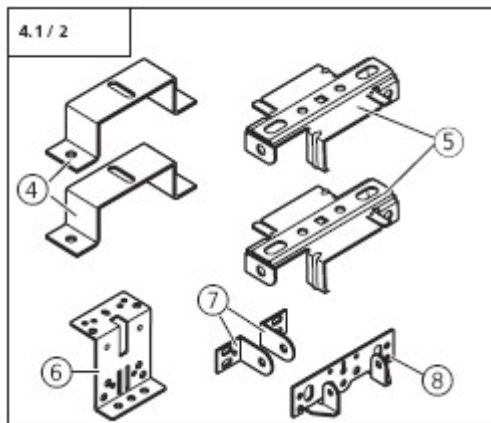

- 4- Boom clamps (2x)
- 5- Suspension cramps (2x)
- 6- Door connector element
- 7- Door link bracket (2x)
- 8- Lintel joining plate

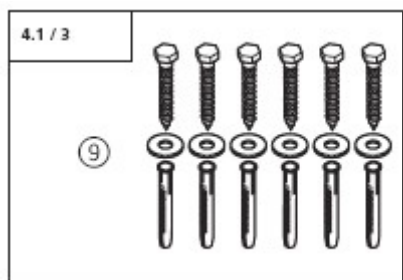

- 9- Fixing materials for the boom

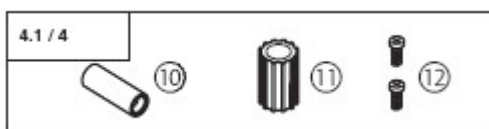

- 10- Securing sleeve
- 11- Adapter sleeve
- 12- Screw 4.0 x 10 (2x)

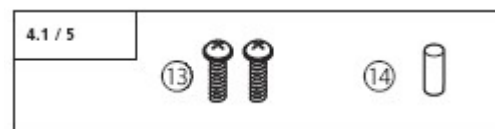

- 13- Screw 4.0 x 18 (2x)
- 14- Bolt 8 x 20

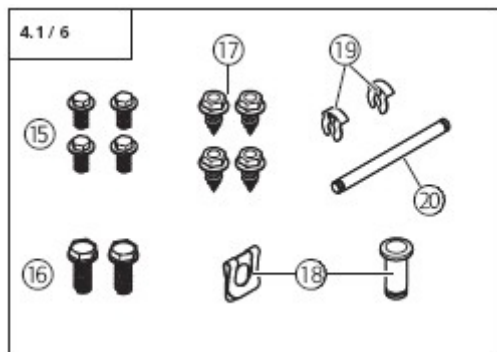

- 15- Screw 6 x 14 (4x)
- 16- Hexagonal head screw M6 x 20 (2x)
- 17- Self-tapping screw 6.3 x 16 (4x)
- 18- Bolt A8 with locking plate
- 19- Securing clips (2x)
- 20- Pivot bolt  $\varnothing$  6

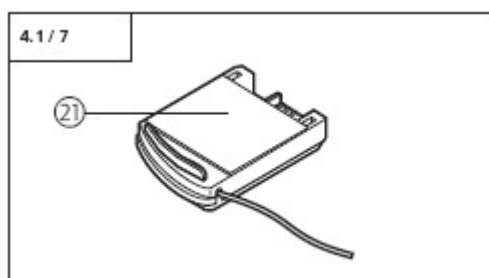

- 21- Modular antenna 433MHz

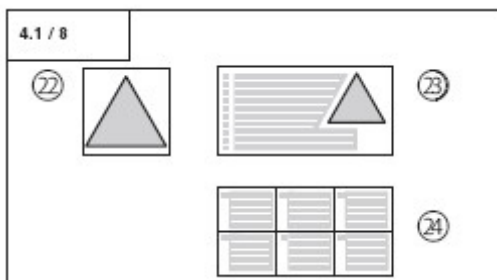

- 22- Warning sign for disengaging
  - 23- Warning sticker
  - 24- Sticker for express programming
- In addition to the components included in the standard package, the following accessories are required for the installation:
- drive boom

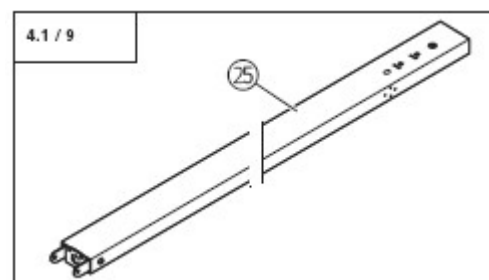

#### Drive booms

The motor unit can be combined with various types of drive boom (see table page 6).

- 25- Drive boom

## 4.2 Door variations

The standard package with the appropriate operator boom is suitable for the following types of door.

### Swing out retractable up-and-over door

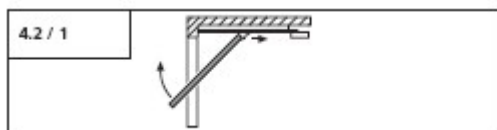

### Sectional door, up to 3 m wide

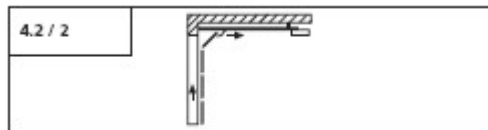

Special accessories are necessary for the following door type.

### Non-swing out retractable up-and-over door

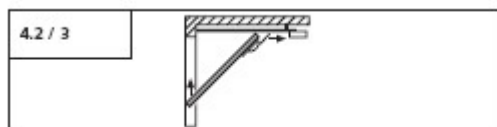

## TABLE WITH SUGGESTIONS FOR THE SELECTION OF PUSH-PULL ACTUATOR MODELS EN05 - EN10 ON RESIDENTIAL SECTIONAL DOORS

**IMPORTANT: FOR OPTIMAL OPERATION THE SECTIONAL DOOR MUST BE PERFECTLY BALANCED.**

Designed for residential garage doors of single or double-family residences. For heavy-use doors providing access to a condominium garage, we recommend type EN10. H: Door height L: Door width

Guide	H/L (mm)	2.000	2.500	3.000	3.500	4.000	4.500	5.000	5.500	6.000
<b>EN11</b>	2.250	EN05	EN05	EN05	EN05	EN05	EN10	EN10	EN10	EN10
<b>EN12</b>	2.500	EN05	EN05	EN05	EN05	EN10	EN10	EN10	EN10	EN10
<b>EN13</b>	3.250	EN05	EN05	EN05	EN10	EN10	EN10	EN10	EN10	EN10



### Attention!

In order to guarantee correct mounting, carry out the following checks before installing.

## 5. Preparation for mounting

### Supply package

- Check the package to ensure that all the parts are included.
- Check that you have all the additional components that are necessary for your particular installation requirements.

### Garage

- Check whether your garage has a suitable mains connection and a mains disconnection facility.

### Door



### Attention!

For garages without a second entrance: the garage door must be fitted with an emergency release system to allow access to the garage if a fault occurs.

If a release kit is used:

- Check that the door locks are functioning correctly. The door locks may not be disabled under any circumstances.

If a release kit is not used:

- Dismantle or disable the door locks.
- Check that the door to be operated fulfils the following conditions:
  - the door must be easily moveable by hand,
  - the door should automatically remain in every position into which it was moved.



**Reference:**  
 When using and installing accessories,  
 always observe the specific instructions in-  
 cluded with the equipment.

## 6. Installation

### 6.1 Installing the motor unit and drive boom

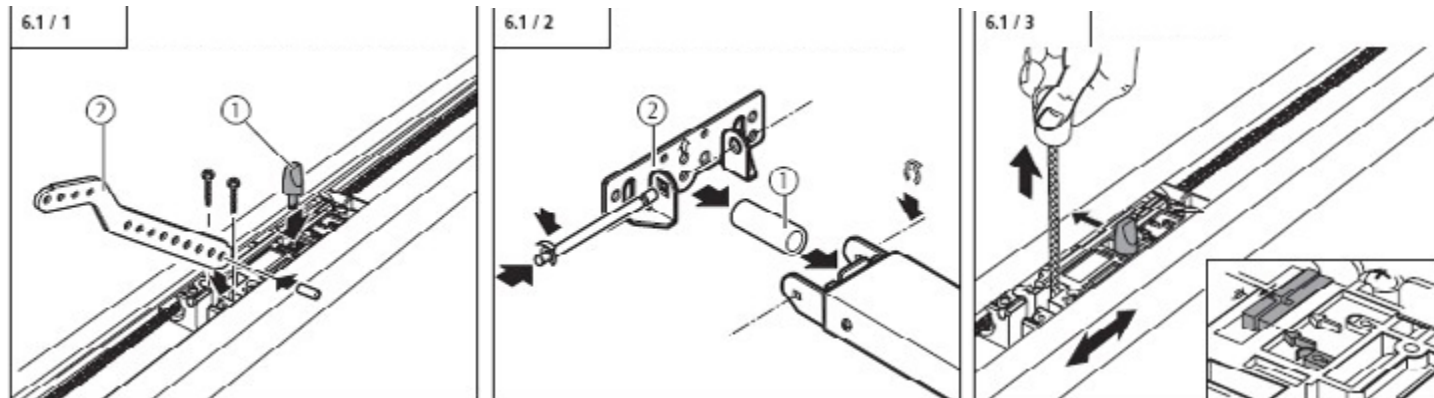

1. Insert unlocking pin.  
 2. Mount door link.

1. Insert securing sleeve.  
 2. Mount lintel joining plate.

Unlock carriage.

#### 6.1.1 Mounting in line



**Attention!**  
 The drive boom must be carefully mounted on the motor unit.  
 Do not use force, as this could damage the gear teeth!

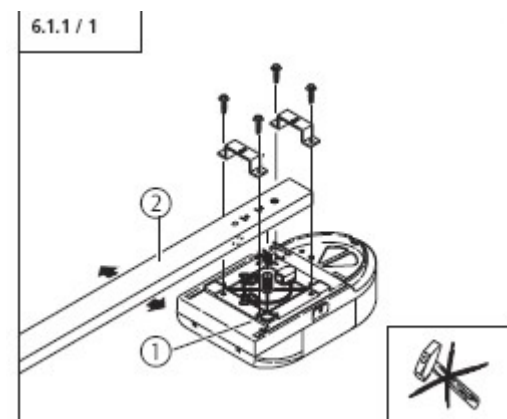

1. Put adapter sleeve onto drive shaft.  
 2. Mount the rail on the motor housing.

#### 6.1.2 Mounting at right angles



**Attention!**  
 - The drive boom must be carefully mounted on the motor unit.  
 Do not use force, as this could damage the gear teeth!  
 - To ensure that the drive system functions properly, the reference point button must be turned through 90°.

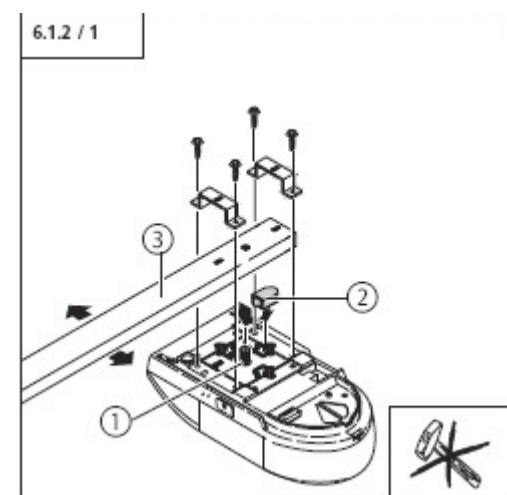

1. Push the adaptor sleeve onto the drive shaft  
 2. Position the reference point button correctly  
 3. Mount the rail on the motor housing

## 6.2 Monting to the door



### Caution!

The operator system must be prevented from falling before it has been properly fixed.

### Attention!

To ensure that the door travels correctly:

- the drive rail must be mounted vertically above the door link bracket.
- at the highest point of the opening movement, the upper edge of the door leaf must lie 10 - 50 mm below the horizontal lower edge of the drive rail.

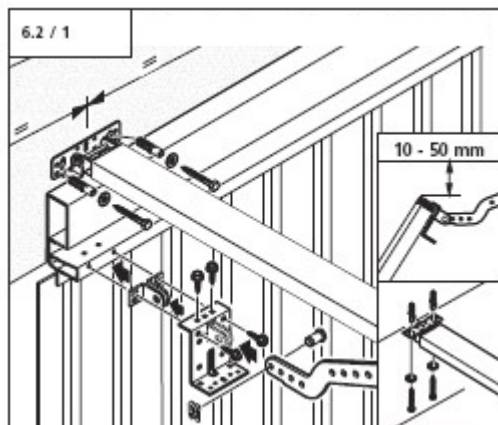

Mounting at the up-and-over door

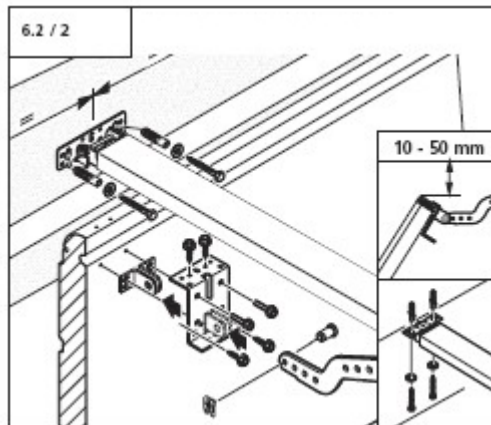

Mounting at the sectional door

## 6.3 Mounting on the ceiling

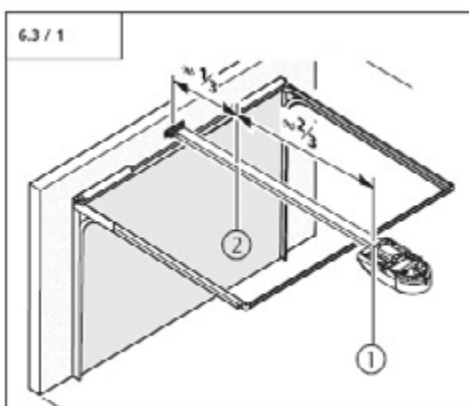

Determine mounting positions 1 and 2

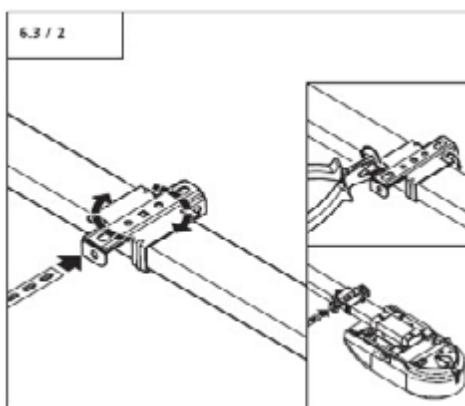

Mount the suspension cramps at the mounting positions.

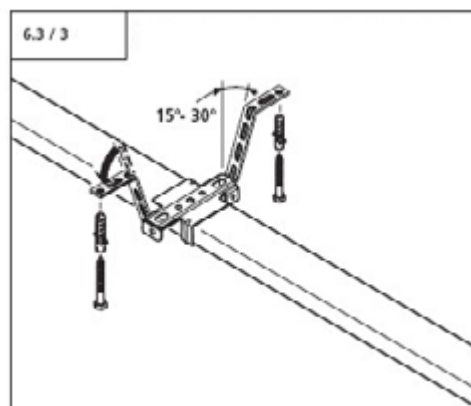

Piegare le staffe forate secondo necessità e fissarle al soffitto.

## 6.4 Release



### Caution!

Uncontrolled door movements may occur when the release function is activated.

- if the door springs are weak or broken;
- or if the door is not balanced

When opening the door manually, the carriage can collide with the motor unit.

If the door has been released, it should only be moved at a moderate speed!

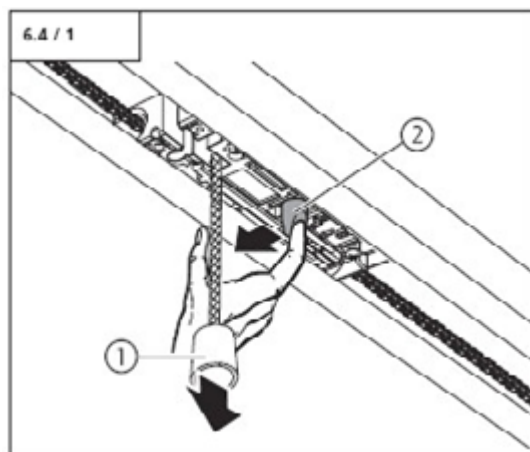

- Construct a physical barrier to limit the extent of the door travel in the opening direction.
- Check that the release pull cord is at a minimum height of 1.8 m.
- Attach the "release warning sign" to the release pull cord.

1. Disconnect the door from the motor unit.
2. Re-connect the door to the motor unit.

## 6.5 Connection of control elements

**STOP** **Caution!**  
Danger of electric shock:  
Before any cabling works begin, it must be ensured that the cables are disconnected from the power supply.  
During cabling works, it must be ensured that the cables remain disconnected from the power supply at all times (e.g. prevent reconnection).

**Attention!**  
In order to avoid damaging the controls:

- The local safety regulations must be complied with at all times.
- It is very important that mains cables are laid separately from control cables.
- The controls voltage must be 24 V DC.
- If external voltages are applied at terminals XP020, XB10 or XB01, the entire electronic system will be destroyed.
- Only potential-free normally open contacts may be connected to terminals 1 and 2 (XB01).
- The shorting plug should never be plugged into the XP020 system socket!

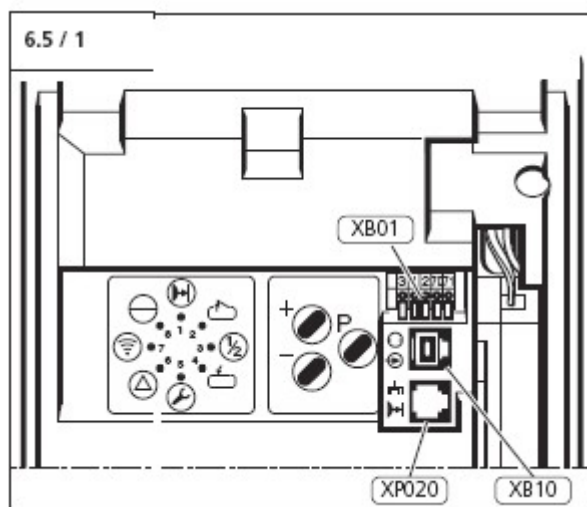

Label	Type / function	
XB01	Connection of external control elements without system cabling and two-wire photocell	6.5 / 2
XB10	Not in use	-
XP020	Terminal for N.C. contact Type EN0C (optional) for addition of a second control or photocell.	-

Connecting possibilities.

**Reference:**  
When installing external control elements, or safety and signal equipment, the relevant instructions must be observed.

**Advice:**  
Before connecting a control element to the terminals with system sockets, the corresponding shorting plug must first be removed.

**Terminal XB01: It is possible to connect an external control (selector or push-button) or photocells**

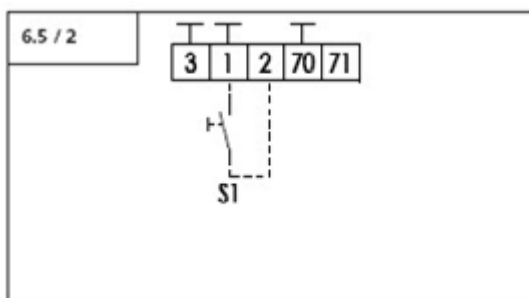

**Connection of the ELVOX photocell to XB01**

Label	Type / function	
1	COM, -	-
2	N.C. (contact) or N.O. (contact)	8.2 / Level 5
3	-	-

**Reference:**  
Once the ELVOX photocell is connected, the programmable impulse input must be programmed to the function C1 (drive system stops and reverses).  
Programming of the photocell is described in chapter 8.2 / menu 5.

Label	Type / function	
1	GND connection	
2	Programmable impulse input	8.2 / Level 5
3	+ 24 V DC connection (max. 50 mA)	-
70	Has no function	-
71	Has no function	-
S1	Connection example: External impulse button	8.2 / Level 5

- plug **XP020**: it is possible to incorporate an additional NC contact (optional), type EN0C, to enable the use of an external control (selector or push-button) and photocells (24V supply voltage).

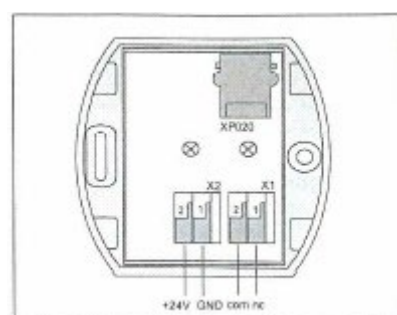

## 6.6 Connection of ELVOX flashing light type ELA3 (supply voltage 230V) to courtesy light terminal

**Important!**  
 To prevent damaging the insulating sheath of the electrical cable, always lay the cable so that it is not in contact with the courtesy light bulb.

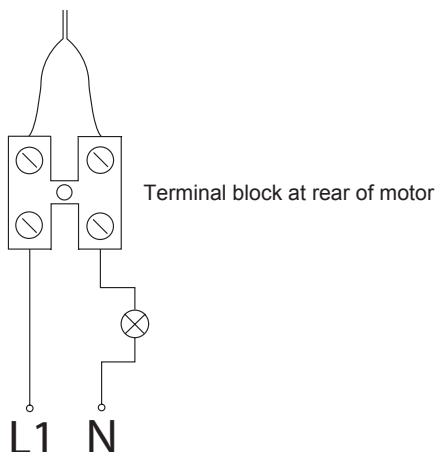

- Remove the courtesy light guard.
- Connect the flashing light.
- Set the desired function (level 3, menu 1).
- Refit the courtesy light guard.

## 7. Initial operation

### 7.1 Connecting the operator system

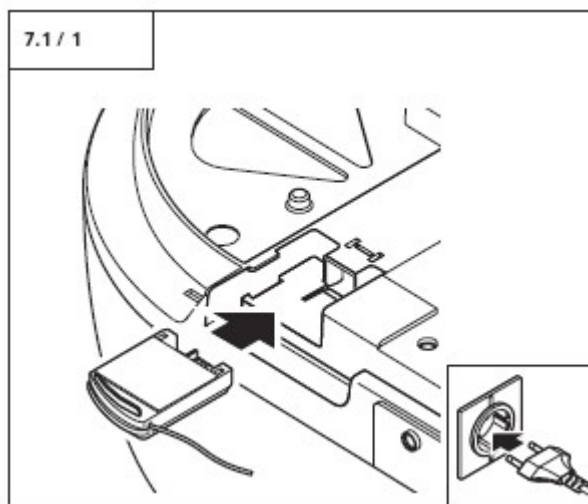

7.2 Overview of the control unit

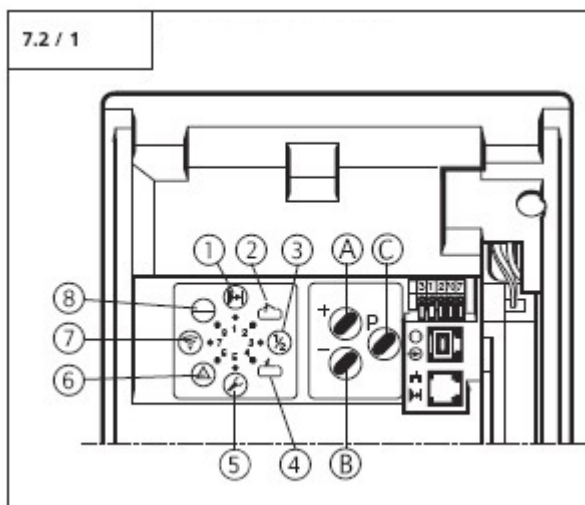

#### LED displays









- 1 Photocell (only lights up if the photocell beam is interrupted)
- 2 Door OPEN position
- 3 Intermediate position
- 4 Door CLOSED position
- 5 Check reference point
- 6 Has no function
- 7 Impulse signal (remote control, external control elements)
- 8 Operation





#### Operating elements:

- A (+) button (e.g. to drive the door to the OPEN position or to increase parameters when programming)
- B (-) button (e.g. to drive the door to the CLOSED position or to decrease parameters when programming)
- C (P) button (e.g. to switch to programming mode or to save parameters)

### 7.3 Overview of the display functions

#### LED displays in operating mode

	Photocell beam interrupted
	Door moving towards OPEN position
	Door in OPEN position
	Door moving towards CLOSED position
	Door in CLOSED position
	Reference point is switched
	Permanent actuation of an external control element
	Remote control is actuated
	Operating voltage

Legend:	
LED off	
LED on	
LED flashes slowly	
LED pulses	
LED flashes quickly	
Factory default setting	
Not possible	-

### 7.4 Express programming



**Advice:**

For proper initial operation of the operator system, the express programming procedure must be carried out. This applies for the initial operation and after resetting.

**Preconditions**

The following conditions must be assured before express programming can commence:

- the door must be in the CLOSED end position.
- the carriage must be connected up.



**Advice:**

When programming the OPEN and CLOSED door positions, the reference point must be passed.

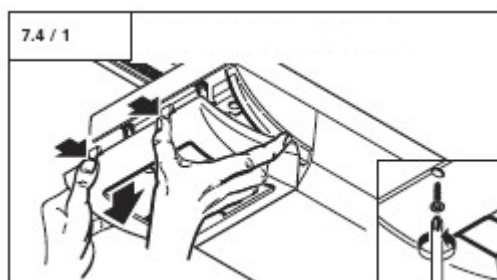

Removing the cover panel.

The controls are programmed using the plus (+), minus (-) and (P) buttons.

If no buttons are pressed within 120 seconds while in programming mode, the controls revert to operating mode.





















A corresponding message is displayed.

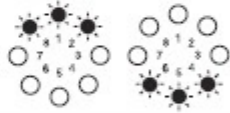

**Reference:**

The messages are explained in Section 9.

- Carry out the express programming according to the following procedure.

 <p>Operating mode</p>	1.		<p><b>Start express programming / Programme the door OPEN end position</b></p>	
	2.		<p>Drive the door to the OPEN position</p>	
	3.		<p>Correct the OPEN door position using (+) and (-)</p>	
	4.		<p><b>Save the OPEN door position / Programme the CLOSED door position</b></p>	
	5.		<p>Drive the door to the CLOSED position</p>	
	6.		<p>Correct the CLOSED door position using (+) and (-)</p>	
	7.		<p><b>Save the CLOSED door position / Programme the remote control</b></p>	
	8.		<p>Press the hand transmitter button</p>	
	9.		<p>Release the hand transmitter button</p>	
	10.		<p><b>Save the remote control settings / End the express programming procedure</b></p>	



**QUICK PROGRAMMING EN05 - EN10**

1. With the door in the closed position, power up the actuator.  
 LED no.8, which indicates the presence of power, and LED no.4, which indicates that the door is closed, must both be on ○.
  
2. To start quick programming, press key P until the three LEDs no.8 - no.1 – no.2 at the top light up.
  
3. Release key P and press “+”. Keep “+” pressed until the door is fully open. While the door is opening the 3 LEDs will blink.  
 Make any corrections that are necessary using the “-” and “+” keys.
  
4. Press key P to save the opening limit stop.  
 The three red LEDs no.4 – no.5 – no.6 at the bottom light up.
  
5. Release key P and press “-”. Keep “-” pressed until the door is fully closed. While the door is closing the 3 LEDs will blink. Make any corrections that are necessary using the “+” and “-” keys.
  
6. Press key P to save the closing limit stop.  
 The red LEDs no.6 – no.7 (blinking) – n°8 light up.
  
7. Press the radio control key.  
 LED no.7 blinks rapidly to indicate that the code has been saved.
  
8. Press key P to save the radio code and keep it pressed for 1 second.  
 All of the LEDs switch on and off in anti-clockwise order and the actuator exits programming mode and reverts to the start condition (LEDs no.8 and no.4 on).
  
9. To check correct operation, open and close the door by pressing the remote control key.

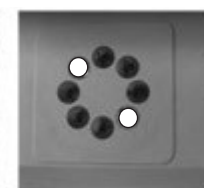
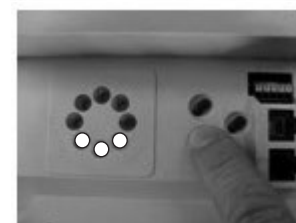
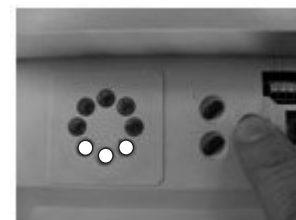
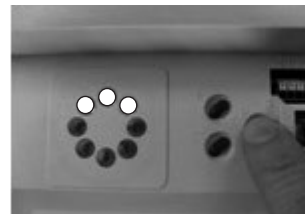
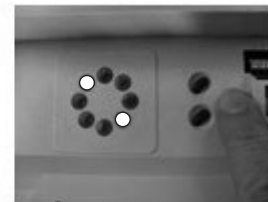
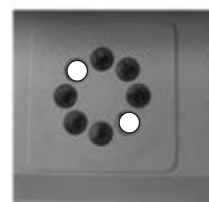

## 7.5 Function test

### 7.5.1 Learning run for determining the driving power



**Check:**

After express programming and after making changes to the programming menu, the following learning runs and checks must be carried out.

The operator system determines the maximum required driving power during the first two runs after setting the end positions of the door.

- Operate the operator system (with the door coupled) to drive the door once from the CLOSED position to the OPEN position and back to the CLOSED position without interruption.

During this learning run, the operator system determines the maximum push and pull forces and the reserve power required to move the door.

**Test:**

1.		After pressing the (+) button: The door must open and travel to the saved OPEN end position.
2.		After pressing the (-) button: The door must close and travel to the saved CLOSED end position.
3.		After pressing the hand transmitter button: The operator system must move the door in either the OPEN or CLOSE direction.
4.		After pressing the hand transmitter button while the operator system is running: The operator system must stop.
5.		When the button is pressed again, the operator system moves in the opposite direction.

### 7.5.2 Checking the automatic cut-out



**Caution!**

The automatic cut-out must be correctly programmed for the CLOSE and OPEN directions to prevent damage to persons or property.

**Automatic cut-out, OPENING**

For drive systems where the door has openings in the door wing (diameter of opening > 50 mm):

- Apply a load of 20 kg to the middle of the lower edge of the door whilst the door is running.

**The door must stop immediately.**

**Automatic cut-out, CLOSING**

- Place a 50 mm high obstacle on the ground.
- Drive the door towards the obstacle.  
The drive system must stop and reverse when it comes into contact with the obstacle.



**Advice:**

The parameter settings are still saved if the power supply is disconnected. Only a reset causes the driving power settings for the OPEN and CLOSE directions to revert to the factory settings.

**8. Extended operator functions**

**8.1 Programming structure for extended operator functions (Example for Level 2, Menu 2)**

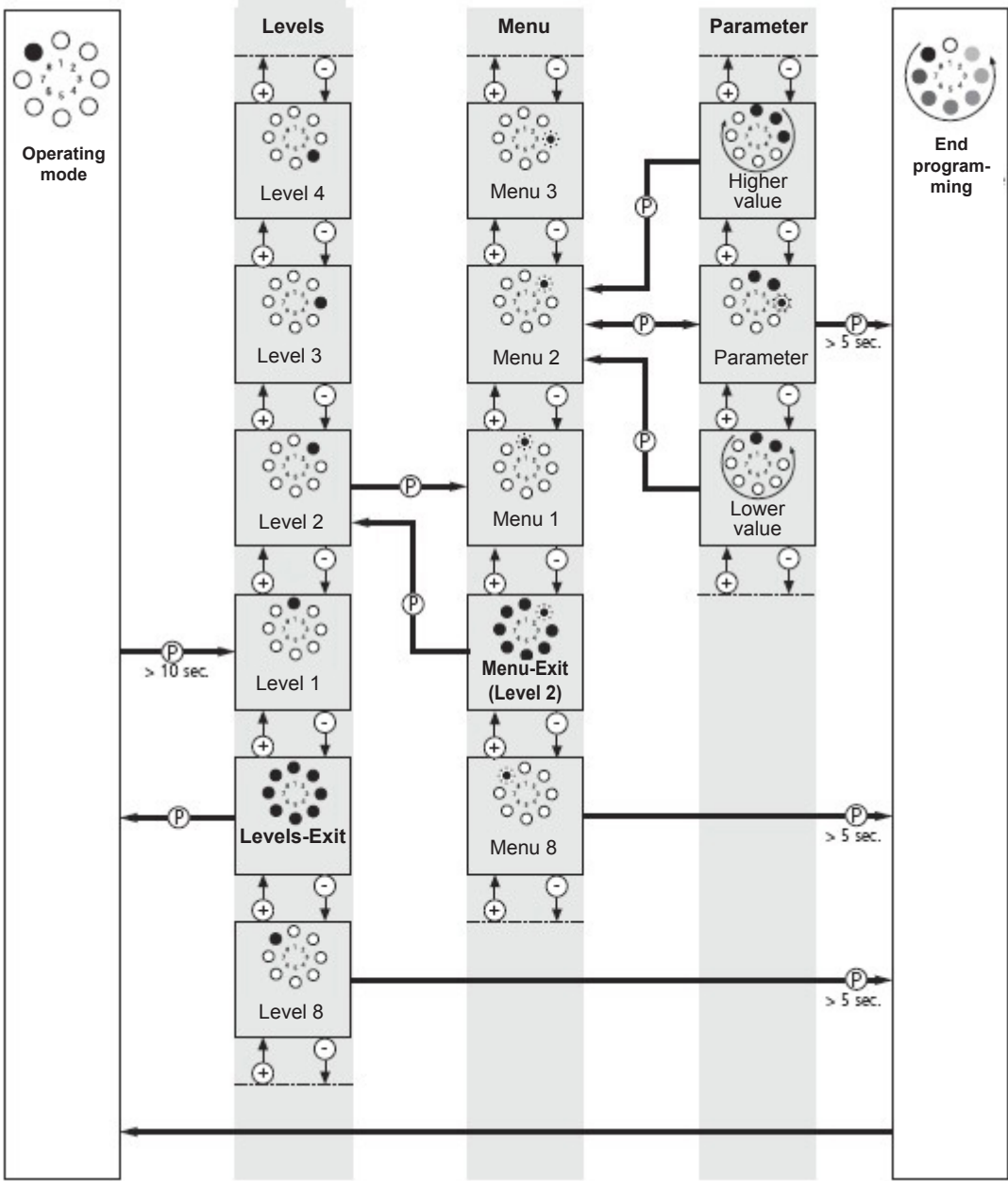

## 8.2 QUICK SETTING OF ADVANCED PROGRAMMING FUNCTIONS



1. Press and hold button (P) for > 10 sec;
2. Wait until all of the LEDs switch off in anticlockwise sequence, as far as the first LED Level (1);

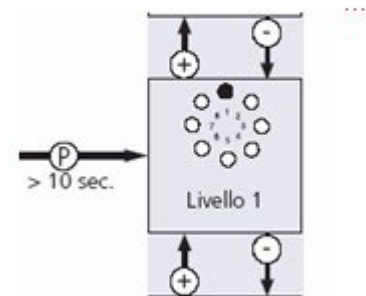

3. Release button (P);
4. Using the (+) and (-) buttons, select the desired level and press button (P) to display the level Menu (red LED blinking);

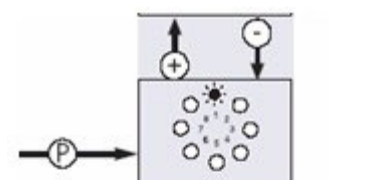

5. Select the desired Menu using the (+) and (-) buttons;
6. Press button (P) to enter the Menu (red LED blinks rapidly);

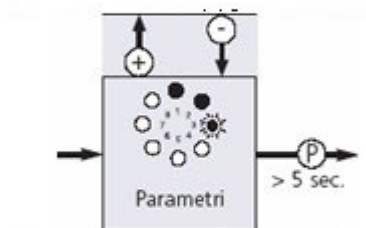

7. Using the (+) and (-) buttons modify the functions or value, referring to the tables given in the instruction booklet;
8. Having chosen the desired value, press and hold button (P) for >5 sec and release it when the LEDs stop blinking in an anticlockwise sequence.

























End programming

### 8.3 Functions overview for the levels



**Caution!**

Important factory default settings can be changed using the extended functions. All the parameters must be set correctly to avoid damage to persons or property.

Level 1 – Basic functions																
	1	2	3	4	5	6	7	8	9	10	11	12	13	14	15	16
																
<b>Menu 3: Intermediate position OPEN</b>																
	Set using the (+ / OPEN) and (- / CLOSE) buttons "Intermediate position OPEN" – closing function is possible with automatic closing timer															
<b>Menu 4: Intermediate position CLOSE</b>																
	Set using the (+ / OPEN) and (- / CLOSE) buttons															
<b>Menu 5: Soft run position OPEN</b>																
	Set using the (+ / OPEN) and (- / CLOSE) buttons															
<b>Menu 6: Soft run position CLOSED</b>																
	Set using the (+ / OPEN) and (- / CLOSE) buttons															
<b>Menu 7: Relay output</b>																
	A7	B7	C7	D7	E7	F7	G7	H7	-	-	-	-	-	-	-	-
<b>Menu 8: RESET</b>																
	No	Si	-	-	-	-	-	-	-	-	-	-	-	-	-	-



**Attention!**

After a reset, all the parameters revert to the factory settings. In order to ensure that the controls operate properly:

- all the required functions must be re-programmed,
- the remote control unit must be re-programmed,
- the drive system must be driven once to the OPEN and CLOSED door positions.



**Advice:**

- Only the intermediate position that was programmed last can be used.
- If an automatic closing timer is activated (Level 3 / Menu 1), the relay output (Level 1 / Menu 7) cannot be programmed.



**Reference:**

If changes are made in Menus 3 to 6 in Level 1, a new learning run must be carried out for the automatic cut-out. The learning run procedure is described in Section 7.5.1.

**Menu 7: Relay output**

- A7- Drive system running / signal light is on
- B7- Drive system running / signal light flashes
- C7- 3-min. light
- D7- Wiping impulse
- E7- Malfunction
- F7- Push-open security device
- G7- Door position CLOSED
- H7- Door position OPEN

Level 2 – Operator settings																
	1	2	3	4	5	6	7	8	9	10	11	12	13	14	15	16
<b>Menu 1: Required driving power OPEN (sensitivity in increments*)</b>																
	1	2	3	4	5	6	7	8	9	10	11	12	13	14	15	16
<b>Menu 2: Required driving power CLOSE (sensitivity in increments*)</b>																
	1	2	3	4	5	6	7	8	9	10	11	12	13	14	15	16
<b>Menu 3: Automatic cut-out OPEN (sensitivity in increments**)</b>																
	OFF	2	3	4	5	6	7	8	9	10	11	12	13	14	15	16
<b>Menu 4: Automatic cut-out CLOSE (sensitivity in increments**)</b>																
	OFF	2	3	4	5	6	7	8	9	10	11	12	13	14	15	16
<b>Menu 5: Speed OPEN (in increments)</b>																
	1	2	3	4	5	6	7	8	9	10	11	12	13	14	15	16
<b>Menu 6: Speed CLOSE (in increments)</b>																
	1	2	3	4	5	6	7	8	9	10	11	12	13	14	15	16
<b>Menu 7: Soft run speed OPEN (in increments)</b>																
	1	2	3	4	5	6	7	8	9	10	11	12	13	14	15	16
<b>Menu 8: Soft run speed CLOSE (in increments)</b>																
	1	2	3	4	5	6	7	8	9	10	11	12	13	14	15	16

\* The higher the setting, the higher the driving power.  
 \*\* The lower the setting, the more sensitive the automatic cut-out.



**Caution!**

To exclude any risk of injury, the automatic cut-out (Menus 3 and 4) may only be switched to OFF if a photocell barrier or closing edge safety device is installed.



**Reference:**

If changes are made in Menus 5, 6, 7 or 8 in Level 2, another learning run must be carried out for the automatic cut-out. The learning run procedure is described in Section 7.5.1.

Level 3 - Automatic closing timer																
	1	2	3	4	5	6	7	8	9	10	11	12	13	14	15	16
<b>Menu 1: Automatic closing timer</b>																
	A1	B1	C1	D1	E1	F1	G1	H1	I1	-	-	-	-	-	-	-
<b>Menu 3: Door open duration (in seconds)</b>																
	2	5	10	15	20	25	30	35	40	50	80	100	120	150	180	255
<b>Menu 4: Warning time (in seconds)</b>																
	1	2	5	10	15	20	25	30	35	40	45	50	55	60	65	70
<b>Menu 5: Start-up warning (in seconds)</b>																
	0	1	2	3	4	5	6	7	-	-	-	-	-	-	-	-



**Advice:**

- The **automatic closing timer** can only be programmed if a photocell or a closing edge safety device is installed.
- The functions in Menu 1 can be altered as desired via the time settings in Menus 3, 4 and 5.

**Menu 1: Automatic closing timer**

	Door open duration	Warning time	Signal light	Other functions
A1	-	-	-	Automatic closing timer deactivated
B1	15	5	flashes	-
C1	30	5	flashes	-
D1	15	5	flashes	Closes after the photocell barrier has been driven past
E1	30	5	flashes	Closes after the photocell barrier has been driven past
F1	15	5	on	-
G1	30	5	on	-
H1	15	5	on	Closes after the photocell barrier has been driven past
I1	30	5	on	Closes after the photocell barrier has been driven past

**Level 4 – Remote programming**



**Menu 1: Impulse**



LED 7 flashes slowly -> press the hand transmitter button -> LED 7 flashes quickly

**Menu 2: Intermediate position**



LED 7 flashes slowly -> press the hand transmitter button -> LED 7 flashes quickly

**Level 5 – Special function**

	1	2	3	4	5	6	7	8	9	10	11	12	13	14	15	16

**Menu 1: Programmable impulse input – Terminals 1/2**

	A1	B1	C1	D1	E1	-	-	-	-	-	-	-	-	-	-	-
--	----	----	----	----	----	---	---	---	---	---	---	---	---	---	---	---

**Menu 4: Lighting duration (in seconds)**

		5	10	15	20	25	30	35	40	50	80	100	120	150	180	255
--	--	---	----	----	----	----	----	----	----	----	----	-----	-----	-----	-----	-----

**Menu 1: Programmable impulse input – Terminals 1/2**

A1- Impulse (normally open contact only)

B1- Automatic On/Off (normally open contact only)

C1- Drive system stops and reverses (only in CLOSE direction – normally closed contact only / for the programming of the ELVOX photocell)

D1- Impulse OPEN (induction loop – normally open contact only)

E1- Stop (normally closed contact only)

**Level 8 – System settings**

	1	2	3	4	5	6	7	8	9	10	11	12	13	14	15	16

**Menu 1: Photocell**

	A1	B1			-	-	-	-	-	-	-	-	-	-	-	-
--	----	----	--	--	---	---	---	---	---	---	---	---	---	---	---	---

**Menu 1: Photocell (only version with testing)**







A1- Operation without photocell

B1- Operation with system photocell (XP020)







## 9. Messages

### 9.1 Malfunctions without error messages





Error	Cause	Solution
LED 8 does not light up.	- No voltage.	- Check that the mains power supply is operational. - Check the connection to the mains power supply.
	- Thermal overload protection in power transformer was activated.	- Allow the power transformer to cool down.
	- Defective control unit.	- Have the operator system checked.
No reaction on impulse.	- The connection terminals for the "impulse" button were by-passed, e.g. due to a short-circuit or flattened terminals.	- Try temporarily disconnecting any key switches or interior push buttons that are connected to the control unit (Section 6.5): remove the cable from socket XB10, insert the shorting plug and look for cabling errors.
No reaction on impulse from hand transmitter.	- Module antenna is not plugged in.	- Connect the module antenna to the control unit (Section 7.1).
	- The hand transmitter coding does not correspond to the receiver coding.	- Activate hand transmitter again (Section 7.4).
	- Hand transmitter battery is empty.	- Insert new battery.
	- Defective hand transmitter, control unit electronics or module antenna.	- Have all 3 components checked.







Legend:	
LED off	
LED on	
LED flashes slowly	
LED pulses	
LED flashes quickly	
Factory default setting	
Not possible	-

### 9.2 Malfunctions with error messages

Error	Cause	Solution
Message 7 	- If no buttons are pressed within 120 seconds, the programming mode terminates automatically. - OPEN and CLOSED door positions programmed without passing the reference point.	
Message 8 	- Reference point button defective.	- Have the operator system checked.
Message 9 	- No speed sensor impulses, drive system is blocked.	- Have the operator system checked.
Message 10 	- Door movement too stiff. - Door blocked.	- Ensure that the door moves easily.
	- Maximum driving power setting is too low.	- Have the max. driving power (Section 8.2 / Level 2 / Menu 1+2) checked by an expert.
Message 11 	- Excess travel stop.	- Have the operator system checked.
Message 15 	- External photocell interrupted or defective.	- Remove obstacle or have the photocell checked.
	- Programmed for photocell, but no photocell is connected.	- Deactivate or connect the photocell.
Message 16 	- Power sensor for the automatic cut-out is defective.	- Have the motor unit checked.



Error	Cause	Solution
Message 26 	- Undervoltage, operator system overloaded at maximum power setting, 16.	- Have the external power supply checked.
Message 28 	- Door movement too stiff or irregular. - Door blocked.	- Check the path of the door and ensure that the door moves easily.
	- Automatic cut-out is set to be too sensitive.	- Have the automatic cut-out facility checked by an expert (Section 8.2 / Level 2 / Menu 3+4).
Message 35 	- Electronics are defective.	- Have the operator system checked.
Message 36 	- Shorting plug removed, although a stop button is not connected. - Closed circuit is interrupted.	- Connect stop button or insert shorting plug (Section 6.5).

Legend:	
LED off	
LED on	
LED flashes slowly	
LED pulses	
LED flashes quickly	
Factory default setting	
Not possible	-

## Table des matières

1. Explication des symboles .....	40
2. Consignes générales de sécurité .....	41
3. Caractéristiques techniques EN05, EN10 .....	42
4. Vue d'ensemble du produit .....	43
4.1 Fourniture EN05, EN10 .....	43
4.2 Les différentes portes .....	44
5. Préparations au montage .....	44
6. Montage .....	45
6.1 Montage de la tête et du rail d'opérateur .....	45
6.2 Montage sur la porte .....	46
6.3 Montage au plafond .....	46
6.4 Déverrouillage .....	46
6.5 Bornier et prises .....	47
6.6 Raccordement du clignotant ELVOX Art. ELA3 (alimentation 230V) à la borne de la veilleuse .....	48
7. Mise en service .....	48
7.1 Branchement de l'opérateur .....	48
7.2 Présentation de l'unité électronique .....	48
7.3 Fonctions des diodes lumineuses .....	49
7.4 Programmation rapide .....	49
7.5 Vérification des fonctions .....	52
8. Fonctions évoluées de l'opérateur .....	53
8.1 Déroulement de la programmation évoluée (Exemple pour le niveau 2, menu 2) .....	53
8.2 Programmation rapide des fonctions de pointe .....	54
8.3 Présentation des fonctions des niveaux .....	55
9. Signalisations .....	58
9.1 Pannes non signalées .....	58
9.2 Pannes signalées .....	58

## 1. Explication des symboles



### Prudence ! Risque de dommages corporels !

Vous trouverez ici d'importantes consignes de sécurité à observer scrupuleusement pour éviter des dommages corporels !



### Attention ! Risque de dommages matériels !

Vous trouverez ici d'importantes consignes de sécurité à respecter scrupuleusement pour éviter des dommages matériels !



### Remarque / Conseil



### Contrôle



### Référence

Les suivants renseignements concernant la sécurité sont partie intégrantes et essentielles du produit et doivent être remis à l'utilisateur. Les lire attentivement car il fournissent importantes indications concernant l'installation. Il est nécessaire de conserver le présent manuel et de le transmettre aux autres possibles futurs usagers. L'installation erronée ou l'emploi impropre du produit peut être source de grave danger.

### IMPORTANT - RENSEIGNEMENTS POUR LA SÉCURITÉ

- L'installation doit être effectuée par personnel professionnellement compétent et conforme à la législation nationale et européenne en vigueur.
- Après avoir enlevé l'emballage s'assurer de l'intégrité de l'appareil, en cas de doute s'adresser à personnel qualifié.
- Les éléments de l'emballage (boîtes, sachets de plastique, agrafes, polystirène etc.) doivent être recyclés ou éliminés en utilisant les poubelles prévues à cet effet pour ramassage différencié, surtout ils ne doivent pas être laissés à la portée des enfants.
- La mise en œuvre, les raccordements électriques et les réglages doivent être effectués parfaitement; les données de la plaque doivent être conformes à celles du réseau électrique et s'assurer que la section des câbles de raccordement soit adaptée aux charges appliqués; en cas de doute s'adresser à personnel qualifié.
- Ne pas installer le produit dans des environnements avec danger d'explosion ou dérangés par des champs électromagnétiques. La présence de gaz ou fumées inflammables constitue un grave danger pour la sécurité.
- Prévoir sur le réseau d'alimentation une protection contre les extratensions: un interrupteur/sectionneur et/ou différentiel appropriés au produit et en conformité aux normes en vigueur.
- Indiquer clairement sur la grille, porte, rideau roulant et barrière (au moyen d'une plaque appropriée) qu'ils sont gérés à distance.
- ELVOX S.p.A. décline toute responsabilité pour des dommages éventuels à cause d'une installation des dispositifs et/ou composants incompatibles aux buts de l'intégrité du produit, de la sécurité et du fonctionnement.
- L'appareil devra être destiné qu'à l'usage pour lequel il a été conçu, toute autre application doit être considérée comme impropre et donc dangereuse.
- Avant d'effectuer une opération de nettoyage ou d'entretien quelconque, débrancher l'appareil en enlevant la fiche ou en déclenchant l'interrupteur de l'installation.  
Pour la réparation ou remplacement des parties endommagées, il faut utiliser seulement pièces détachées et composants d'origine.
- L'installateur doit fournir tous les renseignements relatifs au fonctionnement, à l'entretien et à l'emploi des composants individuels et du système dans sa globalité.



### Directive 2002/96/CE (WEEE, RAEE)

Le symbole de panier barré se trouvant sur l'appareil indique que le produit, à la fin de sa vie utile, doit être traité séparément des autres déchets domestiques et remis à un centre de collecte différencié pour appareils électriques et électroniques ou remis au revendeur au moment de l'achat d'un nouvel appareil équivalent.

L'utilisateur est responsable du traitement de l'appareil en fin de vie et de sa remise aux structures de collecte appropriées. La collecte différenciée pour le démarrage successif de l'appareil remis au recyclage, au traitement et à l'élimination écocompatibles contribue à éviter les effets négatifs environnementaux et sur la santé tout en favorisant le recyclage des matériaux dont se compose le produit. Pour des informations plus détaillées sur les systèmes de collecte disponibles, contacter le service local d'élimination des déchets ou le magasin qui a vendu l'appareil.

### Risques liés aux substances considérées dangereuses (WEEE).

Selon la Directive WEEE, substances qui sont utilisées depuis long temps habituellement dans des appareils électriques et électroniques sont considérées dangereuses pour les personnes et l'environnement. La collecte sélective pour le transfert suivant de l'équipement destiné au recyclage, au traitement et à l'écoulement environnemental compatible contribue à éviter possibles effets négatifs sur l'environnement et sur la santé et favorise le recyclage des matériaux dont le produit est composé.

## 2. Consignes générales de sécurité

### A lire absolument !

#### Groupe-cible

Cet opérateur doit être monté, raccordé et mis en service exclusivement par un personnel qualifié et instruit qui :

- dispose de connaissances relatives aux dangers liés aux interventions sur des installations électriques.
- dispose de connaissances sur les règles se rapportant à l'électrotechnique,
- dispose d'une formation aux premiers secours et à l'utilisation d'équipements de sécurité,
- est suffisamment instruits et encadrés par des électriciens qualifiés,
- a la capacité de reconnaître les dangers liés à l'électricité,
- dispose de connaissances dans l'application de la norme EN 12635 (exigences concernant l'installation et l'utilisation).

#### Garantie

La garantie concernant la fonctionnalité et la sécurité d'utilisation entrera en vigueur si les consignes contenues dans ces instructions ont été respectées. La non-observation des présentes consignes peut conduire à des blessures corporelles et des dégâts matériels.

Le fabricant ne sera pas responsable des dommages imputables à un non-respect des consignes.

Les piles, les fusibles et les ampoules sont des consommables exclus de la garantie.

Afin d'éviter toute erreur pouvant occasionner un endommagement de la porte et de l'opérateur, il est impératif de suivre scrupuleusement les indications de la notice de montage. Le produit pourra seulement être mis en service après avoir pris connaissance de la notice de montage et d'entretien correspondante.

Les instructions de montage et de service sont à remettre à l'utilisateur de l'installation et à conserver.

Elles contiennent d'importantes informations concernant l'utilisation, les vérifications et la maintenance.

Le produit est fabriqué conformément aux normes et directives citées dans la déclaration de conformité constructeur et le certificat de conformité. Le produit a quitté l'usine dans un état de sécurité technique sans défauts.

Avant la première mise en service, les fenêtres, portes et portails motorisés doivent être vérifiés par un spécialiste et entretenus au moins une fois par an et selon les besoins (avec justificatif écrit).

#### Application conforme

L'opérateur a été conçu pour l'ouverture et la fermeture exclusives de portes de garage.

La mise en service est uniquement autorisée dans les pièces sèches.

La force maximum de traction et de poussée doit être respectée.

#### Exigences de la porte

La porte doit :

- S'arrêter en auto-maintien (grâce à un équilibrage à ressorts),
- avoir un mouvement facile.

En plus des consignes contenues dans ces instructions, il faut respecter les règlements généraux sur la sécurité et sur la prévention des accidents ! Nos conditions générales de vente et de livraison entrent en vigueur.

#### Consignes concernant le montage de l'opérateur

- Vérifiez le bon état mécanique de la porte.
- Vérifiez si la porte stoppe dans toute position.
- Vérifiez si la porte est facile à déplacer dans les deux sens de manoeuvre.
- Vérifiez si la porte s'ouvre et se ferme correctement.
- Enlevez toutes les pièces inutiles de la porte (câble, chaîne, équerre par exemple).
- Mettez hors fonction tous les dispositifs devenus inutiles après le montage de l'opérateur.
- Avant les travaux de câblage, il est indispensable de débrancher l'opérateur.
- Pendant les travaux, l'alimentation électrique doit impérativement restée coupée.
- Respectez les normes locales en vigueur.
- Pour éviter tout phénomène d'induction, il est impératif de séparer dans deux gaines différentes les câbles d'alimentation 230 V des câbles d'asservissement basse tension pour raccordement d'appareils périphériques tels que contacteurs ou cellules etc..
- La tension de service est de 24 V DC.
- Montez l'opérateur sur une porte fermée uniquement.
- Tous les éléments d'impulsions et les dispositifs de commande (digicodeur par ex.) doivent être montés à portée visuelle de la porte et à une distance suffisante de sécurité par rapport aux pièces mobiles de la porte. Il est important de respecter une hauteur de montage minimum de 1,5 mètres.
- Appliquez les plaques d'avertissement, (risque de pincement), en évidence et durablement.
- Après le montage, vérifiez qu'aucune pièce de la porte ne déborde sur les passages piétons ou voies publiques.
- Consignes concernant la mise en service de l'opérateur. Après mise en service de l'installation, l'utilisateur de la porte ou son représentant doit être informé avec précision sur le fonctionnement.
- Vérifiez que les éléments de commande de la porte sont hors de portées des enfants.
- Avant de mettre la porte en mouvement, vérifiez si la zone de débattement est bien libre de toute personne et de tout objet.
- Vérifiez tous les dispositifs de sécurité présents.
- Ne jamais toucher une porte ou des pièces mobiles en mouvement.
- Attention aux points de la porte à risques éventuels de pincement et d'écrasement. Les directives de la norme EN 13241-1 doivent être respectées.

#### Consignes concernant la maintenance de l'opérateur

Pour garantir un fonctionnement correct, les points suivants doivent être régulièrement contrôlés et remis en état, le cas échéant.

Avant tous travaux sur la porte, l'opérateur devra toujours être mis hors tension.

- Vérifiez une fois par mois si l'opérateur inverse bien son sens de marche dès que la porte touche un obstacle. Pour cela, veuillez placer un obstacle de 50 mm de haut et de large dans la zone de débattement de la porte, en respectant son sens de marche.
- Vérifiez le réglage de force en OUVREMENT et FERMETURE.
- Vérifiez toutes les pièces mobiles de la porte et de l'opérateur.
- Vérifiez si la porte présente d'éventuelles traces d'usure ou des dommages.
- Vérifiez le fonctionnement aisé manuel de la porte.

#### Consignes concernant l'entretien de l'opérateur

A proscrire : un jet d'eau direct, un nettoyeur haute pression, des acides ou une eau savonneuse.

### 3. Caractéristiques techniques

#### Caractéristiques électriques

- Tension nominale	230 V	230 V
- Fréquence nominale	50 Hz	50 Hz
- Courant absorbé	0,7 A	0,7 A
- Puissance absorbée en service	0,2 KW	0,26 A
- Puissance absorbée en veille	< 3,9 W	< 3,9 W
- Mode de service (Service intermittent)	Durée de marche 2 min.	Durée de marche 2 min.
- Tension d'entrée	24 V DC	24 V DC
- Type de protection de la tête d'opérateur	IP 20	IP20
- Catégorie de protection	II	II

#### Caractéristiques mécaniques

- Force maxi en traction et poussée	500 N	1000N
- Vitesse de marche	140 mm/s	140 mm/s
- Délai d'ouverture (spécifique à la porte)	15 s env.	15 s env.

#### Environnement

- Dimensions de la tête d'opérateur	160x215x395 mm	160x215x395 mm
- Poids	5,90 kg	6,70 kg
- Plage de température	-20 à +60 °C	-20 à +60 °C

#### Fournitures

- Tête d'opérateur EN05 avec unité électronique intégrée
- Antenne électronique

#### Caractéristiques/ Fonctions de sécurité

- Technique du point de référence
- Démarrage progressif/ arrêt progressif
- Sécurité anti-effraction
- Arrêt automatique de sécurité
- Dispositif anti-blocage
- Protection contre la sous-tension
- Limitation du temps de marche
- Déconnexion terminale électronique
- Branchement pour le bouton-poussoir, le digicodeur et le contacteur à clé
- Branchement du contact de fin de course libre de potentiel
- Signalisation des erreurs

## 4. Vue d'ensemble du produit

### 4.1 Fourniture EN05, EN10

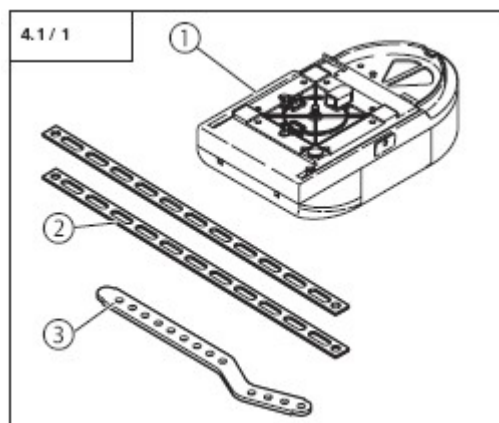

- 1- Tête d'opérateur EN05, EN10  
2- Tôle de suspension  
3- Trainard galbé

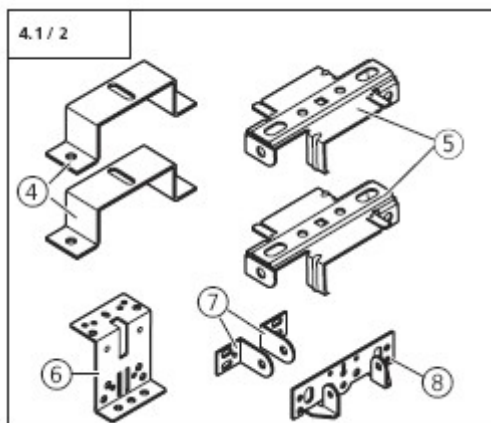

- 4- Pincés à rail (2x)  
5- Crampon de suspension (2x)  
6- Élément de raccordement de la porte  
7- Equerres d'entraînement de la porte (2x)  
8- Patte de fixation

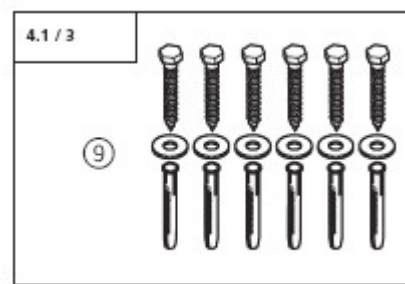

- 9- Matériel de fixation du rail

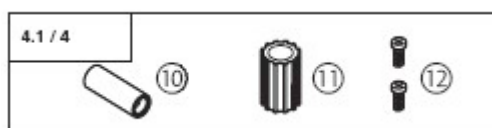

- 10- Manchon de sécurité  
11- Douille adaptatrice  
12- Vis 4,0 x 10 (2x)

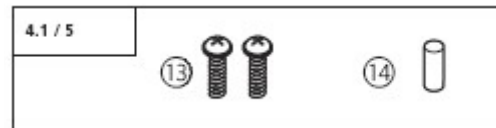

- 13- Vis 4,0 x 18 (2x)  
14- Goujon 8 x 20

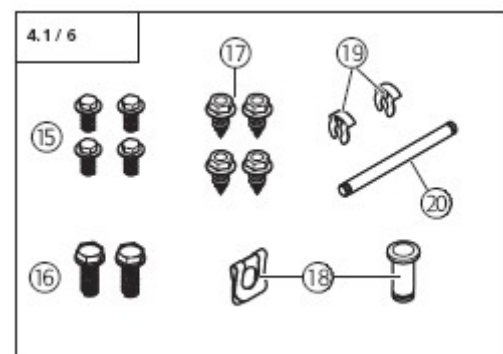

- 15- Vis 6 x 14 (4x)  
16- Vis à tête hexagonale M6 x 20 (2x)  
17- Vis à tête 6,3 x 16 (4x)  
18- Goujon A8 avec sécurité SL  
19- Clips de sécurité (2x)  
20- Axe d'articulation ø 6

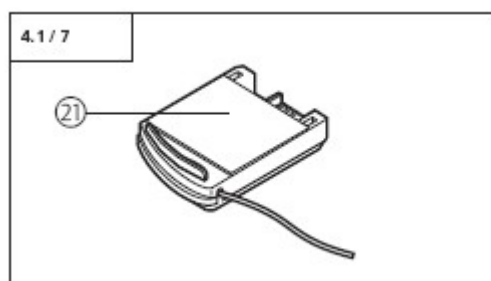

- 21- Antenne électronique 433 MHz

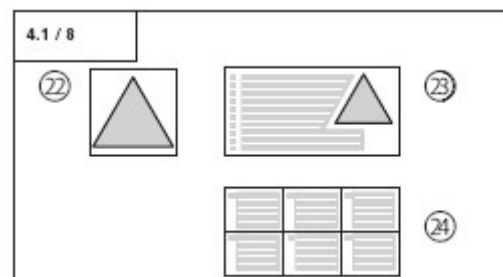

- 22- Plaque d'avertissement déclenchement  
23- Autocollant d'avertissement  
24- Autocollant Programmation rapide  
En plus de la fourniture standard, les accessoires suivants sont nécessaires au montage :  
- rail d'opérateur

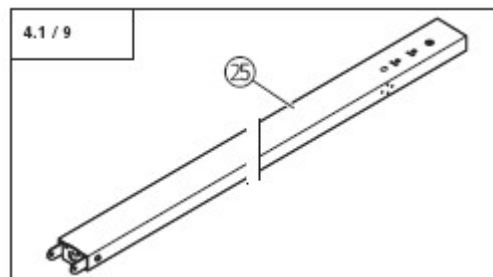

#### Rails d'opérateur

La tête d'opérateur peut être combinée avec des rails différents (table pag. 6).

- 25- Rail d'opérateur

## 4.2 Les différentes portes

La fourniture standard avec le rail d'opérateur correspondant est adaptée aux exécutions de portessuivantes.

### Porte basculante débordante

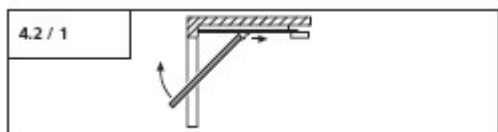

### Porte sectionnelle ayant une largeur inférieure ou égale à 3 m.

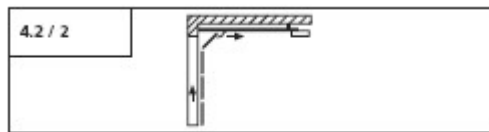

Des accessoires spéciaux sont indispensables au type de porte suivant :

### Porte basculante non débordante

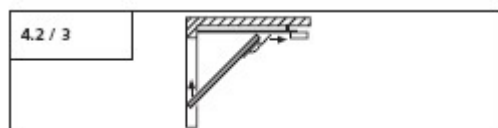

## TABLEAU POUR SUGGÉRER LE MODÈLE D'AUTOMATISME À TRACTION EN05 – EN10 SUR PORTES SECTIONNELLES RÉSIDENNELLES

**ATTENTION: L'ÉQUILIBRAGE PARFAIT DE LA PORTE SECTIONNELLE EST FONDAMENTAL POUR UN FONCTIONNEMENT OPTIMAL.**

L'emploi prévu est celui résidentiel, pour portes de garages d'habitations à un ou deux appartements. Lorsque les portes permettent l'accès à un garage de copropriété, avec passage intensif, nous conseillons l'art. EN10. H: Hauteur porte L: Largeur porte

Guide	H/L (mm)	2.000	2.500	3.000	3.500	4.000	4.500	5.000	5.500	6.000
<b>EN11</b>	2.250	<b>EN05</b>	<b>EN05</b>	<b>EN05</b>	<b>EN05</b>	<b>EN05</b>	<b>EN10</b>	<b>EN10</b>	<b>EN10</b>	<b>EN10</b>
<b>EN12</b>	2.500	<b>EN05</b>	<b>EN05</b>	<b>EN05</b>	<b>EN05</b>	<b>EN10</b>	<b>EN10</b>	<b>EN10</b>	<b>EN10</b>	<b>EN10</b>
<b>EN13</b>	3.250	<b>EN05</b>	<b>EN05</b>	<b>EN05</b>	<b>EN10</b>	<b>EN10</b>	<b>EN10</b>	<b>EN10</b>	<b>EN10</b>	<b>EN10</b>



### Attention !

Afin de garantir un montage correct, effectuez les contrôles suivants avant de débiter le travail.

## 5. Préparations au montage

### Fournitures

- Vérifiez l'intégralité des fournitures.
- Vérifiez la présence des accessoires nécessaires au montage envisagé.

### Garage

- Vérifiez si votre garage est équipé d'une alimentation électrique et d'un dispositif de coupure appropriés.

### Porte



### Attention !

Si le garage n'a pas de seconde entrée :

Afin de pouvoir pénétrer dans le garage en cas de panne, la porte du garage devra être équipée d'un déverrouillage d'urgence.

S'il y a utilisation d'un kit de déverrouillage:

- Vérifiez la bonne fonctionnalité des verrous de la porte. Ne mettez en aucun cas les verrous de la porte hors fonction.

S'il n'y a pas utilisation d'un kit de déverrouillage:

- Démontez les verrous mécaniques de la porte ou mettez-les hors fonction en position ouverte !
- Vérifiez si la porte à manoeuvrer remplit les conditions suivantes :
  - La porte doit être facilement manoeuvrable à la main.
  - La porte doit s'arrêter automatiquement dans toute position.



**Référence :**  
 Lors de l'utilisation et du montage d'accessoires, il est impératif de respecter les instructions correspondantes.

## 6. Montage

### 6.1 Montage de la tête et du rail d'opérateur

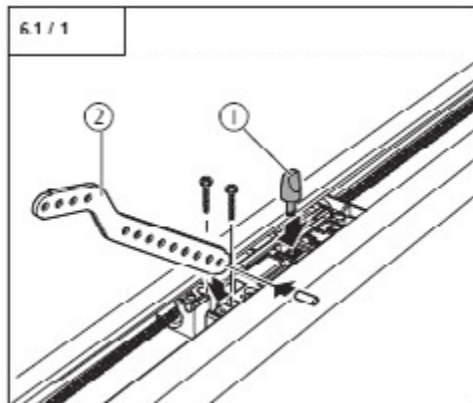

1. Placer le tenon de déverrouillage.
2. Montage de l'entraînement.

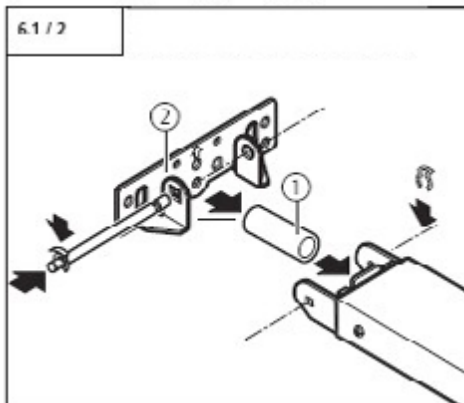

1. Installer le manchon de sécurité.
2. Montage de la patte de fixation.

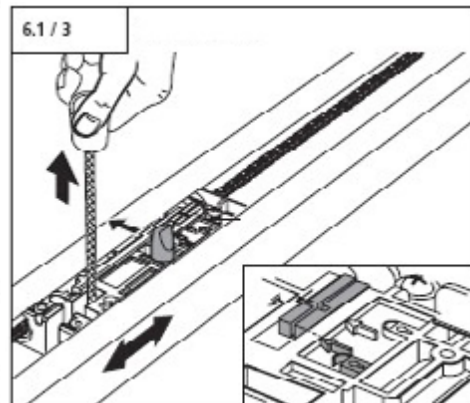

Déclencher le chariot.

#### 6.1.1 Montage droit



**Attention !**  
 Le rail doit être monté sur la tête d'opérateur avec précaution.  
 Ne surtout pas forcer, sinon la denture peut s'abîmer !

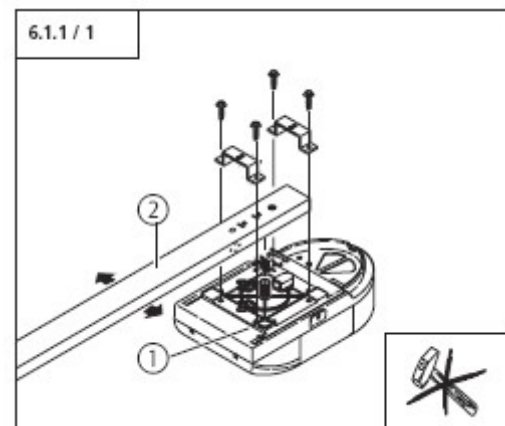

1. Enfoncer la douille sur l'arbre de transmission.
2. Montage des rails sur le boîtier du moteur.

#### 6.1.2 Montage transversal



**Attention !**  
 - Le rail doit être monté sur la tête d'opérateur avec précaution.  
 Ne surtout pas forcer, sinon la denture peut s'abîmer !  
 - Pour assurer la fonction de l'opérateur, le bouton du point de référence doit être déplacé de 90°.

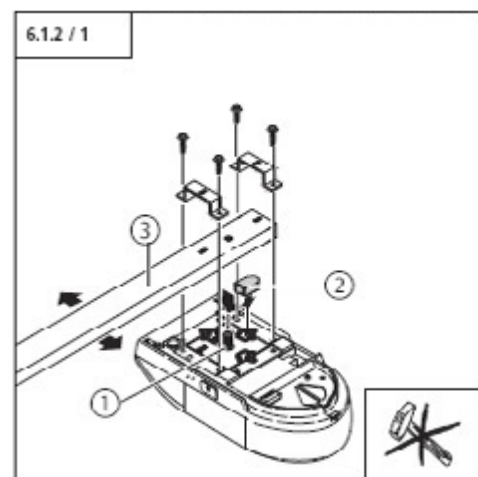

1. Enfoncer la douille sur l'arbre de transmission.
2. Déplacer le bouton du point de référence.
3. Montage des rails sur le boîtier du moteur.

## 6.2 Montage sur la porte



### Prudence!

Jusqu'à sa fixation, il faut assurer l'opérateur contre les chutes.

### Attention!

Pour garantir un fonctionnement sans problème de la porte:

- Le rail de l'opérateur doit être monté à la verticale au-dessus de l'équerre d'entraînement,
- Il doit y avoir de 10 mm à 50 mm de jeu entre la partie la plus haute de la porte en mouvement et la partie inférieure horizontale du rail de l'opérateur.

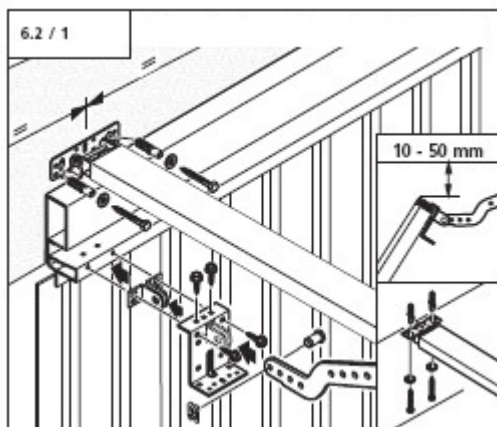

Montage sur porte basculante non débordante.

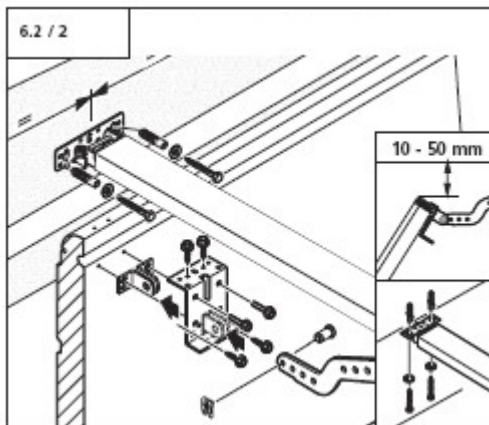

Montaggio sur porte sectionnelle.

## 6.3 Montage au plafond

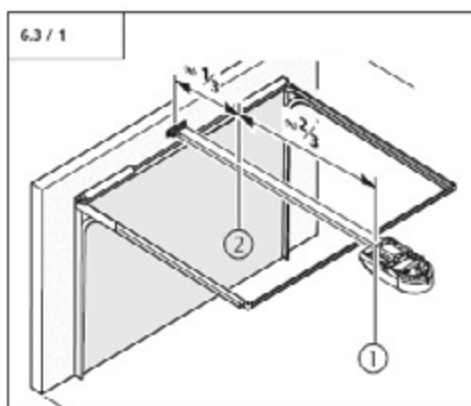

Déterminer les positions de montage 1 et 2.

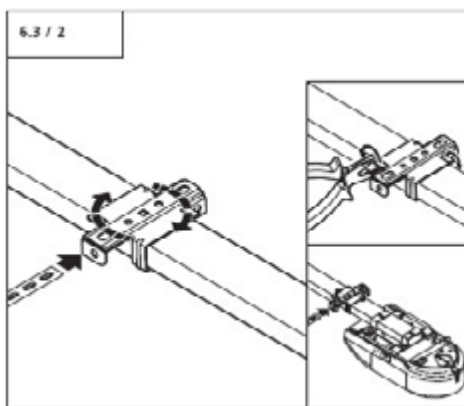

Monter les crampons de fixation aux positions déterminées.

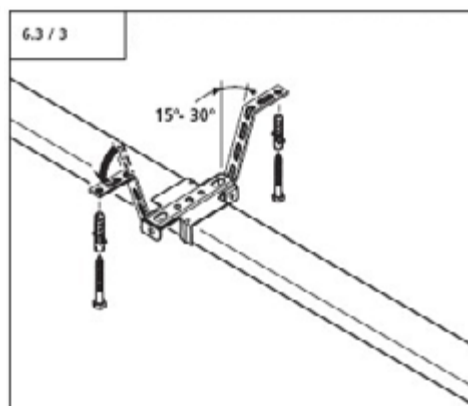

Courber les tôles de fixation et les monter au plafond.

## 6.4 Déverrouillage



### Prudence!

En actionnant le déverrouillage, la porte peut effectuer des mouvements incontrôlés:

- Si les ressorts de la porte sont faibles ou cassés.
- Si la porte n'est pas bien équilibrée.

En ouvrant manuellement la porte, le chariot de guidage peut entrer en collision avec la tête d'opérateur.

Une porte déverrouillée doit être manoeuvrée lentement !

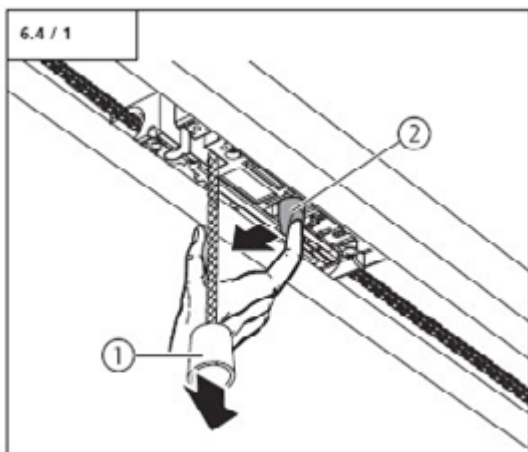

- Transformez la construction pour limiter le trajet de la porte dans le sens d'ouverture.
- Vérifiez la hauteur minimum d' 1,8 m de la tirette.
- Appliquez l' Avertissement déverrouillage sur la tirette.

1. Déclencher le portail et la tête d'opérateur.
2. Enclencher le portail et la tête d'opérateur.



## 6.5 Bornier et prises



### Prudence !

Risque d'électrocution :

Avant tous travaux de câblage, vérifier si les câbles sont bien hors tension. Pendant les travaux de câblage, faire en sorte que les câbles restent hors tension (en parant à tout possibilité de remise sous tension par exemple).



### Attention !

Pour éviter les endommagements de la commande :

- Respecter à tous moments les normes locales en vigueur.
- Pour éviter les phénomènes d'induction, il est impératif de séparer dans des gaines différentes les câbles d'asservissement des câbles d'alimentation du moteur.
- La tension du circuit de commande est de 24 V DC
- Une tension étrangère aux branchements XP020, XB10 ou XB01 entraîne la destruction de l'ensemble de l'électronique.
- Seuls des contacts à fermeture libre de potentiel peuvent être branchés aux bornes 1 et 2.
- La fiche de court-circuitage ne doit pas être fichée dans la prise XP020 du système !

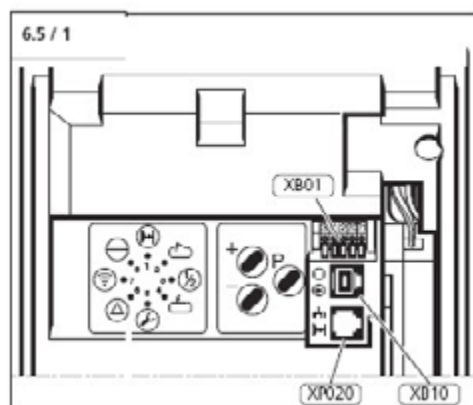

Possibilidades de conexión.



### Référence :

Pour le montage d'éléments fonctionnels externes, de dispositifs de sécurité et de signalisation, il est impératif de respecter les instructions correspondantes.



### Remarque :

Avant de brancher un élément fonctionnel aux prises femelles du système, il faut enlever la fiche de court-circuitage correspondante.

### Branchement XB01:

Il est possible de raccorder une commande extérieure (sélecteur ou bouton) ou des photocellules.

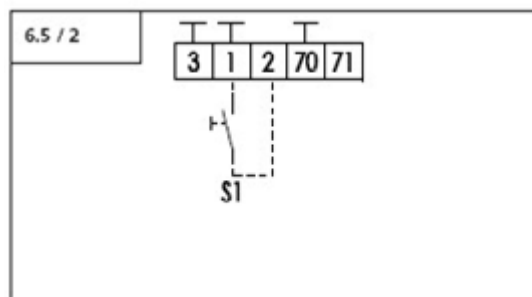

### Branchement de la cellule photo ELVOX à XB01

Désignation	Type / Fonction	
1	COM, -	-
2	NC (CONTACT REPOS) - NO (CONTACT OUVERT)	8.2 / Niveau 5
3	-	-



### Rinvio:

Dopo avere collegato la fotocellula ELVOX, occorre impostare il Contatto programmabile scegliendo il parametro C1 (Stop e inversione). Questa programmazione è descritta al Paragrafo 8.2, Livello 5.

Désignation	Type / Fonction	
XB01	Branchement d'éléments de commande externes sans câblage du système et sans cellule photoélectrique bifilaire.	6.5 / 2
XB10	Pas en usage	-
XP020	Borne pour contact N.F. Réf. EN0C (option) pour ajouter une deuxième commande ou photocellule	-

Désignation	Type / Fonction	
1	Branchement GND	
2	Entrée impulsion programmable	8.2 / Niveau 5
3	Branchement + 24 V DC (max. 50 mA)	-
70	Sans fonction	-
71	Sans fonction	-
S1	Exemple de branchement: Bouton externe à impulsion	8.2 / Niveau 5

- plug **XP020** : on peut avoir un contact NF supplémentaire (en option), art EN0C, pour l'emploi d'une commande externe (sélecteur ou bouton) et des photocellules (alimentation 24V).

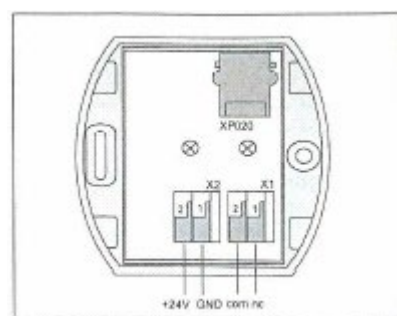

## 6.6 Raccordement du clignotant ELVOX Art. ELA3 (alimentation 230V) à la borne de la veilleuse



### Attention !

Pour éviter d'endommager la gaine isolante du câble électrique, poser toujours le câble de manière à ce qu'il n'entre pas en contact avec l'ampoule de la veilleuse.

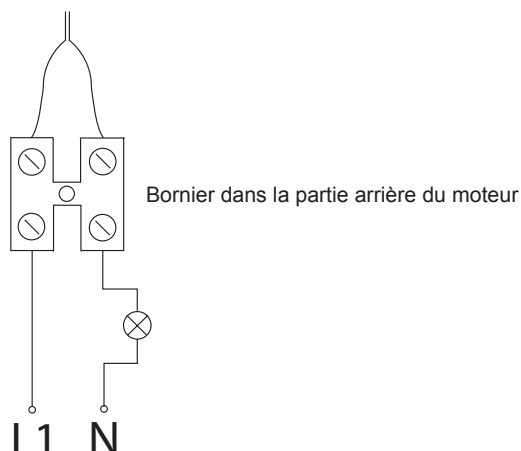

- Enlever le carter de la veilleuse.
- Relier le clignotant.
- Programmer la fonction désirée (niveau 3, menu 1).
- Repositionner le carter de la veilleuse.

## 7. Mise en service

### 7.1 Branchement de l'opérateur

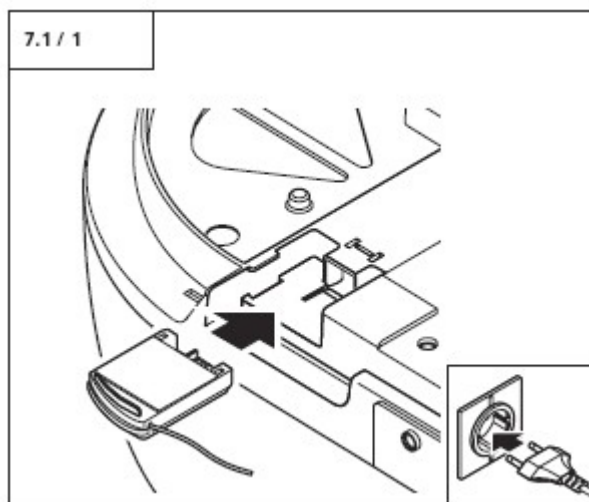

Encaster l'antenne électronique et établir l'alimentation électrique.

### 7.2 Présentation de l'unité électronique

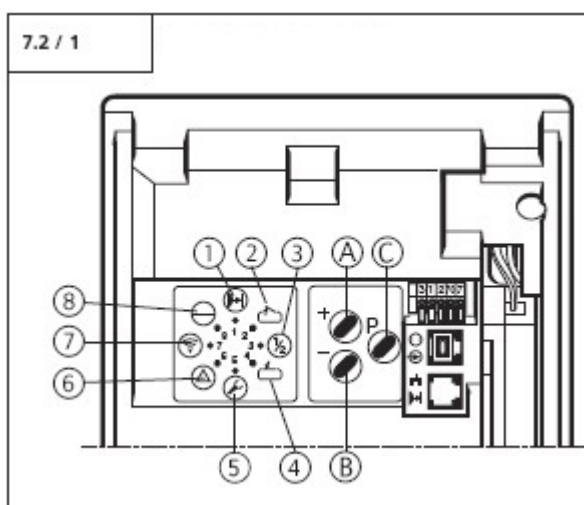

#### Diodes lumineuses

- 1- Cellule photoélectrique (s'allume uniquement si le faisceau lumineux de la cellule photoélectrique est interrompu)
- 2- Fin de course OUVERTURE
- 3- Position intermédiaire
- 4- Fin de course FERMETURE
- 5- Contrôle du point de référence
- 6- Sans fonction
- 7- Envoi d'impulsion (télécommande, éléments fonctionnels externes)
- 8- Fonctionnement









Présentation de la commande.







#### Éléments de commande

- A Bouton (+) (Déplacer la porte en fin de course OUVERTURE ou augmenter un paramètre lors de la programmation par exemple)
- B Bouton (-) (Déplacer la porte en fin de course FERMETURE ou diminuer un paramètre lors de la programmation par exemple)
- C Bouton (P) (Passer au mode de programmation ou mémoriser un paramètre par exemple)

### 7.3 Fonctions des diodes lumineuses

#### Signification des diodes allumées en mode de service

	Faisceau lumineux de la cellule photoélectrique interrompu
	La porte se déplace dans le sens d'OUVERTURE
	La porte est en fin de course OUVERTURE
	La porte se déplace dans le sens de FERMETURE
	La porte est en fin de course FERMETURE
	Le point de référence sera commuté
	Actionnement continu d'un élément de commande externe
	La télécommande sera actionnée
	Commande sous tension

Légende :	
Diode éteinte	
Diode allumée	
Diode clignote lentement	
Diode clignote rythmiquement	
Diode clignote rapidement	
Réglage d'usine	
Impossible	

### 7.4 Programmation rapide



**Remarque :**

Pour une mise en service correcte de l'opérateur, il est impératif d'effectuer la programmation rapide. Cela est valable pour la première mise en service et après une remise à zéro.

**Conditions**

Satisfaire aux conditions suivantes avant d'effectuer la programmation rapide :

- La porte se trouve en fin de course FERMETURE.
- Le chariot de guidage est accouplé.



**Remarque :**

Lors de la programmation des fins de course OUVERTURE et FERMETURE, il est indispensable de passer par le point de référence.

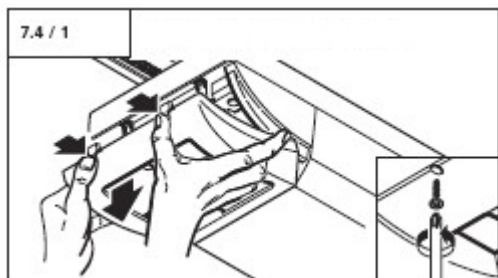

Retrait du cache.

Les boutons plus (+), moins (-) et (P) permettent de programmer.





















Si, en mode de programmation, aucun bouton n'est activé pendant 120 s, la commande reviendra automatiquement en mode de service. Le signal correspondant sera affiché.



**Référence :**

Vous trouverez les explications des signaux en point 9.

• Exécuter la programmation rapide en vous référant au plan ci-après.

 <p>Mode de service</p>	1.		Démarrer la programmation rapide / Programmer la fin de course OUVERTURE	
	2.		Amener la porte en OUVERTURE	
	3.		Correction de la fin de course OUVERTURE avec (+) et (-)	
	4.		Mémoriser la fin de course OUVERTURE / Programmer la fin de course FERMETURE	
	5.		Amener la porte en FERMETURE	
	6.		Correction de la fin de course FERMETURE avec (+) et (-)	
	7.		Mémoriser la fin de course FERMETURE / Programmer la télécommande	
	8.		Activer l'émetteur	
	9.		Relâcher l'émetteur	
	10.		1s Mémoriser la télécommande / Terminer la programmation rapide	

**PROGRAMMATION RAPIDE EN05 - EN10**

1. Avec la porte en position de fermeture totale, alimenter l'actionneur.  
 La led n° 8, qui indique la présence d'alimentation, et la led n° 4, qui indique la porte fermée, doivent être allumées ○.
  
2. Pour commencer la programmation rapide, appuyer sur la touche P jusqu'à l'allumage des trois leds dans la partie supérieure n° 8 - n° 1 - n° 2.
  
3. Relâcher la touche P et appuyer sur le "+". Maintenir le "+" appuyé jusqu'à l'ouverture totale de la porte. Durant l'ouverture de la porte, les 3 leds clignotent. Effectuer les éventuelles corrections en utilisant les touches "-" et "+".
  
4. Appuyer sur la touche P pour mémoriser le fin de course d'ouverture.  
 Les trois leds rouges s'allument dans la partie inférieure, n° 4 - n° 5 - n° 6.
  
5. Relâcher la touche P et appuyer sur la touche "-". Maintenir le "-" appuyé jusqu'à la fermeture totale de la porte. Durant la fermeture de la porte, les 3 leds clignent. Effectuer les éventuelles corrections en utilisant les touches "+" et "-".
  
6. Appuyer sur la touche P pour mémoriser le fin de course de fermeture.  
 Les leds rouges n° 6 - n° 7 (clignotantes) - n° 8 s'allument.
  
7. Appuyer sur la touche de la radiocommande.  
 La led n° 7 indique la mémorisation du code avec un clignotement rapide.
  
8. Appuyer sur la touche P pour mémoriser le code radio et la maintenir appuyée pendant 1 seconde.  
 Toutes les leds s'allument et s'éteignent dans le sens inverse des aiguilles d'une montre et l'actionneur quitte la programmation en retournant dans sa condition initiale (leds n° 8 et n° 4 allumées).
  
9. Pour vérifier le fonctionnement correct, effectuer l'ouverture et la fermeture de la porte en appuyant sur la touche de la radiocommande.

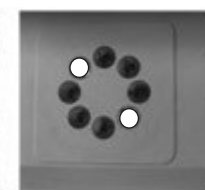
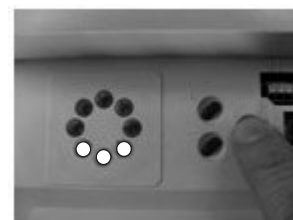
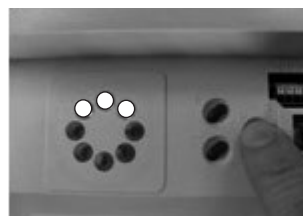
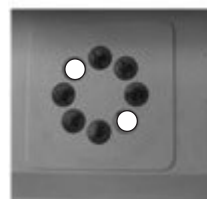

## 7.5 Vérification des fonctions

### 7.5.1 Trajet d'apprentissage pour la puissance d'entraînement

 **Contrôle :**  
Après la programmation rapide et les modifications dans le menu de programmation, les vérifications et les trajets d'apprentissage suivants doivent avoir lieu.

Lors des deux premiers trajets après réglage des fins de course, l'opérateur apprend la puissance maximum d'entraînement nécessaire.

- Amenez l'opérateur (avec porte accouplée), une fois et sans interruption, de la fin de course FERMETURE en fin de course OUVERTURE et vice-versa. Ce trajet d'apprentissage permet à l'opérateur d'établir la force en traction et poussée maximum et la réserve de puissance nécessaire pour déplacer la porte.

#### Contrôle :

1.		Après appui sur bouton (+) : La porte doit s'ouvrir et aller en fin de course OUVERTURE mémorisée.
2.		Après appui sur bouton (-) : La porte doit se fermer et aller en fin de course FERMETURE mémorisée.
3.		Après appui sur le bouton de l'émetteur : L'opérateur doit déplacer la porte dans les deux sens de manoeuvre.
4.		Après appui sur le bouton de l'émetteur alors que l'opérateur est en service : L'opérateur doit s'arrêter.
5.		Au prochain appui, l'opérateur se déplace dans la direction opposée.

### 7.5.2 Contrôle de l'arrêt automatique de sécurité

 **Prudence !**  
L'arrêt automatique de sécurité en OUVERTURE et en FERMETURE doit être réglé correctement pour éviter les dommages corporels et matériels.

#### Arrêt automatique OUVERTURE

En présence d'opérateurs pour portes équipées d'ouvertures dans le battant (diamètre de l'ouverture > 50 mm) :

- Pendant son mouvement, charger le milieu du bas de la porte d'un poids de 20 kg.

**La porte doit immédiatement s'arrêter.**

#### Arrêt automatique FERMETURE

- Placez un obstacle de 50 mm de haut sur le sol.
- Amenez le portail sur l'obstacle. En entrant en contact avec l'obstacle, l'opérateur doit s'arrêter et réverser.

 **Remarque :**  
En cas d'interruption de l'alimentation électrique, les réglages des paramètres restent mémorisés.  
Seule une remise à zéro ramènera les puissances d'entraînement en OUVERTURE et en FERMETURE aux valeurs réglées en usine.



## 8.2 PROGRAMMATION RAPIDE DES FONCTIONS DE POINTE



1. Appuyer sur la touche (P) pendant > 10 sec ;
2. Attendre l'extinction de toutes les leds, dans le sens inverse des aiguilles d'une montre, jusqu'à la première led Niveau (1) ;

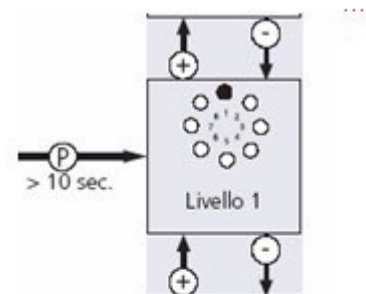

3. Relâcher la touche (P) ;
4. Choisir avec les touches (+) et (-) le niveau désiré et appuyer sur la touche (P) pour afficher le menu du niveau (led rouge clignotante) ;

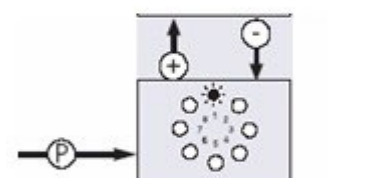

5. Avec les touches (+) et (-), choisir le menu désiré ;
6. Appuyer sur la touche (P) pour entrer dans le menu (la led rouge clignote rapidement) ;

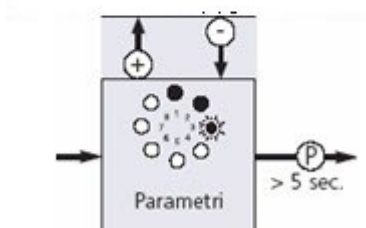

7. Avec les touches (+) et (-) modifier, en se référant aux tableaux présents dans les instructions, les fonctions ou les valeurs ;
8. Après avoir choisi la valeur désirée, appuyer sur la touche (P) pendant >5 sec et la relâcher lorsque les leds arrêtent de clignoter dans le sens inverse des aiguilles d'une montre.



Terminer la programmation

























### 8.3 Présentation des fonctions des niveaux



#### Prudence !

Les fonctions évoluées de l'opérateur permettent de modifier d'importants réglages d'usine. Tous les paramètres doivent être réglés correctement pour éviter les dommages corporels ou matériels.

Niveau 1 - Fonctions de base																
	1	2	3	4	5	6	7	8	9	10	11	12	13	14	15	16
																
<b>Menu 3 : Position intermédiaire OUVERTURE</b>																
	Régler à l'aide des boutons (+ / OUVERTURE) et (- / FERMETURE) « Position intermédiaire OUVERTURE » – la fonction de fermeture est possible avec fermeture automatique															
<b>Menu 4 : Position intermédiaire FERMETURE</b>																
	Régler à l'aide des boutons (+ / OUVERTURE) et (- / FERMETURE)															
<b>Menu 5 : Mouvement amorti en OUVERTURE</b>																
	Régler à l'aide des boutons (+ / OUVERTURE) et (- / FERMETURE)															
<b>Menu 6 : Mouvement amorti en FERMETURE</b>																
	Régler à l'aide des boutons (+ / OUVERTURE) et (- / FERMETURE)															
<b>Menu 7 : Sortie relais</b>																
	A7	B7	C7	D7	E7	F7	G7	H7	-	-	-	-	-	-	-	-
<b>Menu 8 : Retour à l'état initial</b>																
	No	Si	-	-	-	-	-	-	-	-	-	-	-	-	-	-

#### Attention !

Après un retour à l'état initial, tous les paramètres seront ramenés aux réglages d'usine.

Pour garantir un fonctionnement sans problème de la commande :

- la programmation de toutes les fonctions souhaitées doit être refaite,
- la télécommande doit subir un apprentissage,
- l'opérateur doit être déplacé une fois en fin de course OUVERTURE et une fois en fin de course FERMETURE.



#### Remarque :

- Seule la position intermédiaire programmée en dernier pourra être utilisée.
- Si la fonction de fermeture automatique est activée (niveau 3 / menu 1), la sortie relais (niveau 1 / menu 7) n'est pas programmable.



























#### Référence :

Après modifications du niveau 1 dans les menus 3 à 6, il faut refaire un trajet d'apprentissage pour la fonction de fermeture automatique. Le trajet d'apprentissage est décrit en point 7.5.1.



#### Menu 7 : Sortie relais

- A7- Opérateur en service / feu de signalisation allumé
- B7- Opérateur en service / feu de signalisation clignote
- C7- Eclairage pendant 3 minutes
- D7- Impulsion temporisée
- E7- Panne
- F7- Sécurité anti-effraction
- G7- Fin de course FERMETURE
- H7- Fin de course OUVERTURE

Niveau 2 - Réglages de l'opérateur																
	1	2	3	4	5	6	7	8	9	10	11	12	13	14	15	16
																
Menu 1 : Puissance d'entraînement requise en OUVERTURE (sensibilité en degrés*)																
	1	2	3	4	5	6	7	8	9	10	11	12	13	14	15	16
Menu 2 : Puissance d'entraînement requise en FERMETURE (sensibilité en degrés*)																
	1	2	3	4	5	6	7	8	9	10	11	12	13	14	15	16
Menu 3 : Arrêt automatique de sécurité en OUVERTURE (sensibilité en degrés**)																
	Disat-tivata	2	3	4	5	6	7	8	9	10	11	12	13	14	15	16
Menu 4 : Arrêt automatique de sécurité en FERMETURE (sensibilité en degrés**)																
	Disat-tivata	2	3	4	5	6	7	8	9	10	11	12	13	14	15	16
Menu 5 : Vitesse en OUVERTURE (en degrés)																
	1	2	3	4	5	6	7	8	9	10	11	12	13	14	15	16
Menu 6 : Vitesse en FERMETURE (en degrés)																
	1	2	3	4	5	6	7	8	9	10	11	12	13	14	15	16
Menu 7 : Vitesse du mouvement amorti en OUVERTURE (en degrés)																
	1	2	3	4	5	6	7	8	9	10	11	12	13	14	15	16
Menu 8 : Vitesse du mouvement amorti en FERMETURE (en degrés)																
	1	2	3	4	5	6	7	8	9	10	11	12	13	14	15	16

\* plus le degré est élevé, plus la puissance d'entraînement est élevée.

\*\* plus le degré est bas, plus l'arrêt automatique de sécurité réagit sensiblement.























### Prudence !

Pour parer à tous risques de blessures, l'arrêt automatique de sécurité (menus 3 et 4) pourra exclusivement être programmé sur ARRET si une cellule photoélectrique ou un palpeur de sécurité est branché.



### Référence :

Après des modifications des menus 5, 6, 7 et 8 du niveau 2, un nouveau trajet d'apprentissage doit être fait pour l'arrêt automatique de sécurité. Le trajet d'apprentissage est décrit en point 7.5.1.

Niveau 3 - Fermeture automatique																
	1	2	3	4	5	6	7	8	9	10	11	12	13	14	15	16
																
Menu 1 : Fermeture automatique																
	A1	B1	C1	D1	E1	F1	G1	H1	I1	-	-	-	-	-	-	-
Menu 3 : Temps d'ouverture de la porte (en secondes)																
	2	5	10	15	20	25	30	35	40	50	80	100	120	150	180	255
Menu 4 : Période d'avertissement (en secondes)																
	1	2	5	10	15	20	25	30	35	40	45	50	55	60	65	70
Menu 5 : Avertissement de démarrage (en secondes)																
	0	1	2	3	4	5	6	7	-	-	-	-	-	-	-	-



### Remarque :

- La **fermeture automatique** peut uniquement être programmée si une cellule photoélectrique ou un palpeur de sécurité est branché.
- Les fonctions de menu 1 peuvent être modifiées à volonté par les valeurs temps des menus 3, 4 et 5.

## Menu 1 : Fermeture automatique

	Temps d'ouverture de la porte	Temps d'avertissement	Feu de présignalisation	Autres fonctions
A1	-	-	-	Fermeture automatique désactivée
B1	15	5	clignote	-
C1	30	5	clignote	-
D1	15	5	clignote	Fermeture après passage par la cellule photoélectrique
E1	30	5	clignote	Fermeture après passage par la cellule photoélectrique
F1	15	5	allumé	-
G1	30	5	allumé	-
H1	15	5	allumé	Fermeture après passage par la cellule photoélectrique
I1	30	5	allumé	Fermeture après passage par la cellule photoélectrique

## Niveau 4 - Programmation radio



### Menu 1 : Impulsion



















La diode 7 clignote lentement -> Actionner le bouton de l'émetteur portable -> La diode 7 clignote rapidement

### Menu 2 : Position intermédiaire



La diode 7 clignote lentement -> Actionner le bouton de l'émetteur portable -> La diode 7 clignote rapidement

## Niveau 5 - Fonction spéciale

	1	2	3	4	5	6	7	8	9	10	11	12	13	14	15	16
																
<b>Menu 1 : Entrée impulsion programmable - Borne 1/2</b>	A1	B1	C1	D1	E1	-	-	-	-	-	-	-	-	-	-	-
<b>Menu 4 : Temps d'éclairage (en secondes)</b>		5	10	15	20	25	30	35	40	50	80	100	120	150	180	255

### Menu 1 : Entrée impulsion programmable - Borne 1/2

A1- Impulsion (contact à fermeture uniquement)

















B1- Automatique Marche/ Arrêt (contact à fermeture uniquement)

C1- L'opérateur s'arrête et réverse (uniquement dans le sens de FERMETURE - rupteur uniquement / pour la programmation de la cellule photoélectrique ELVOX)

D1- Impulsion OUVERTURE (Boucle à induction – contact à fermeture uniquement)

E1- Arrêt (rupteur uniquement)

## Niveau 8 - Réglages du système

	1	2	3	4	5	6	7	8	9	10	11	12	13	14	15	16
																
<b>Menu 1 : Cellule photoélectrique</b>	A1	B1			-	-	-	-	-	-	-	-	-	-	-	-

### Menu 1 : Cellule photoélectrique (seulement version avec test)







A1) Fonctionnement sans cellule photoélectrique

B1) Fonctionnement avec cellule photo à câble plat (XP020)







## 9. Signalisations





### 9.1 Pannes non signalées







Panne	Cause	Remède
La diode 8 ne s'allume pas.	- Pas de tension.	- Vérifier l'alimentation secteur. - Contrôler le branchement sur secteur.
	- La protection thermique du moteur s'est déclenchée.	- Laisser refroidir le transformateur.
	- Unité de pilotage défectueuse.	- Faire contrôler l'opérateur.
Pas de réaction après envoi d'impulsion.	- Bornes de raccordement pour contacteur « impulsion » pontée (par un court-circuit ou des pinces plates par exemple).	- Séparer de l'unité de pilotage, un par un, les contacteurs et les boutons-poussoirs éventuellement câblés (point 6.5) pour effectuer des essais : Débrancher le câble de la prise XB10, brancher la fiche de court-circuitage puis rechercher l'erreur de câblage.
Pas de réaction après envoi d'impulsion par l'émetteur portable.	- Antenne électronique débranchée.	- Collegare l'antenna ricevente con la centralina (paragrafo 7.1).
	- Codage de l'émetteur portable ne correspond pas au codage du récepteur.	- Réactiver l'émetteur portable (point 7.4).
	- Pile de l'émetteur déchargée.	- Installer une pile neuve.
	- Emetteur portable, antenne électronique ou unité de pilotage défectueux.	- Faire vérifier ces trois éléments.

Légende :	
Diode éteinte	
Diode allumée	
Diode clignote lentement	
Diode clignote rythmiquement	
Diode clignote rapidement	
Réglage d'usine	
Impossible	-

### 9.2 Pannes signalées

Panne	Cause	Remède
Signal 7 	- Après 120 s sans activation d'un bouton, le mode de programmation se ferme automatiquement. - Programmation des fins de course OUVERTURE et FERMETURE sans passage par le point de référence.	
Signal 8 	- Bouton défectueux du point de référence.	- Faire contrôler l'opérateur.
Signal 9 	- Absence d'impulsions du capteur compte-tours. Opérateur bloqué.	- Faire contrôler l'opérateur.
Signal 10 	- La porte est trop difficile à manoeuvrer. - Porte bloquée.	- Rendre la porte manoeuvrable.
	- Puissance maximale d'entraînement réglée trop faiblement.	- Faire vérifier la puissance maximum d'entraînement par votre revendeur spécialisé (point 8.2 / Niveau 2 / menus 1 + 2).
Signal 11 	- Limitation du temps de marche.	- Faire contrôler l'opérateur.
Signal 15 	- Cellule photo externe interrompue ou défectueuse.	- Enlever l'obstacle ou faire vérifier la cellule photo.
	- Cellule photo programmée mais pas raccordée.	- Désactiver la cellule photoélectrique ou la raccorder.
Signal 16 	- Le capteur de courant de l'arrêt automatique de sécurité est défectueux.	- Faire contrôler la tête d'opérateur.

Panne	Cause	Remède
Signal 26 	- Sous-tension, l'opérateur est surchargé lors du réglage de la puissance maximale, degré 16.	- Faire contrôler l'alimentation électrique.
Signal 28 	- La porte est trop difficile à manoeuvrer ou son mouvement est irrégulier. - Porte bloquée.	- Vérifier le mouvement de la porte et la rendre mobile.
	- Arrêt automatique de sécurité réglé trop sensiblement.	- Faire vérifier l'arrêt automatique de sécurité par votre revendeur spécialisé (point 8.2 / Niveau 2 / menus 3 + 4).
Signal 35 	- L'électronique est défectueuse.	- Faire contrôler l'opérateur.
Signal 36 	- Suppression du court-circuitage mais le bouton d'arrêt n'est pas branché. - Le circuit de veille est interrompu.	- Brancher le bouton d'arrêt ou la fiche de court-circuit (point 6.5).

Légende :	
Diode éteinte	
Diode allumée	
Diode clignote lentement	
Diode clignote rythmiquement	
Diode clignote rapidement	
Réglage d'usine	
Impossible	-

## INDICE

1.	Symbolerklärung.....	60
2.	Allgemeine Sicherheitshinweise.....	61
3.	Technische Daten EN05, EN10.....	62
4.	Produktübersicht.....	63
4.1	Lieferumfang EN05, EN10.....	63
4.2	Torvarianten.....	64
5.	Montagevorbereitungen.....	64
6.	Montage.....	65
6.1	Montage von Motor-Aggregat und Antriebsschiene.....	65
6.2	Montage am Tor.....	66
6.3	Montage an der Decke.....	66
6.4	Entriegelung.....	66
6.5	Steuerungsanschlüsse.....	66
6.6	Anschluss der Blinkleuchte ELVOX Art. ELA3 (Anschlussspannung 230V) an der Klemme der Zufahrtsbeleuchtung.....	68
7.	Inbetriebnahme.....	68
7.1	Anschluss des Antriebssystems.....	68
7.2	Übersicht der Steuerung.....	68
7.3	Übersicht der Anzeigefunktionen.....	69
7.4	Schnellprogrammierung.....	69
7.5	Funktionsprüfung.....	72
8.	Erweiterte Antriebsfunktionen.....	73
8.1	Ablaufschema der erweiterten Programmierung (Beispiel für Ebene 2, Menü 2).....	73
8.2	Schnelleinstellung der erweiterten programmierungsfunktionen.....	74
8.3	Funktionsübersicht der Ebenen.....	75
9.	Meldungen.....	78
9.1	Störungen ohne Störmeldeanzeige.....	78
9.2	Störungen mit Störmeldeanzeige.....	79

## 1. Symbolerklärung



**Vorsicht!**  
**Gefahr von Personenschäden!**  
 Hier folgen wichtige Sicherheitshinweise, die zur Vermeidung von Personenschäden unbedingt beachtet werden müssen!



**Achtung!**  
**Gefahr von Sachschäden!**  
 Hier folgen wichtige Sicherheitshinweise, die zur Vermeidung von Sachschäden unbedingt beachtet werden müssen!



**Hinweis / Tipp**



**Kontrolle**



**Verweis**

Die folgenden Informationen sind wesentliche Teile des Produkts und müssen dem Benutzer übergeben werden. Bitte lesen Sie sie aufmerksam, weil Sie wichtige Informationen in Bezug auf die Installation, die Anwendung und die Wartung ausrüsten. Es ist notwendig diese Unterlage bewahren und zu anderen eventuellen Benutzern der Installation zu übermitteln. Eine falsche Installation und eine ungeeignete Anwendung kann gefährlich sein.

### WICHTIGE SICHERHEITSINFORMATIONEN

- Die Intallation muß von Fachpersonal und nach den gültigen nationalen und europäischen Richtlinien durchgeführt werden.
- Nach Entfernung der Verpackung versichern Sie sich über die Unversehrtheit des Aparats. Im Zweifelsfall wenden Sie sich an Fachpersonal.
- Die Verpackungsteile (Plastickbeutel - Karton - Klammern - Polystyrol usw.) sind in den dazu bestimmten Behältern zu entsorgen und dürfen nicht die Umwelt verschmutzen und nicht in der Reichweite von Kindern gelassen werden.
- Das Installieren, die elektrischen Anschlüsse und die Einstellungen dürfen vollkommen durchgeführt werden; versichern Sie sich dass die Daten entsprechen den des elektrischen Netzes und kontrollieren Sie dass der Querschnitt der Anschlußkabel den gegebenen Ladungen geeignet ist. Im Zweifelsfall wenden Sie sich an Fachpersonal.
- Einbauen Sie nicht das Erzeugnis in Umstände mit Gefahr von Explosion oder gestört mit elektromagnetischen Feldern. Die Anwesenheit von entzündbaren Gasen oder Rauchen sind eine Gefahr für die Sicherheit.
- Bei dem Spannungsversorgungsnetz muß einen Schutz gegen Extraspannungen vorgesehen werden: einen dem Produkt geeigneten Schalter/Trennschalter und/oder Differential und konform den gültigen Richtlinien.
- Tor, Tür, Rolladen oder der Schranke müssen ein Schield erhalten, das über eine Fernsteuerung benachrichtigt.
- ELVOX S.p.A kann nicht haftbar gemacht werden für eventuelle Schäden verursachten von der Installierung von ungeeigneten Vorrichtungen und/oder Komponenten, die können die Integrität, Sicherheit und Betrieb des Produkts beschädigen.
- Das Gerät ist nur für seinen geplanten Gebrauch bestimmt, jede andere Anwendung ist als ungeeignet und daher gefährlich zu betrachten.
- Vor Ausführung sämtlicher Reinigungs- oder Wartungsarbeiten, abschalten Sie das Gerät vom Spannungsnetz durch Ausschalten den Stecker oder den Schalter der Installation. Für die Reparatur oder Ersetzung von beschädigten Teilen, nur Originalersatzteile verwenden.
- Der Installateur muß alle Informationen in Bezug auf den Betrieb, die Wartung und den Gebrauch von den einzelnen Komponenten und dem System in seine Totalität ausstatten.



### Richtlinie 2002/96/EG (WEEE)

Das am Gerät angebrachte Symbol des durchgestrichenen Abfallkorbs bedeutet, dass das Produkt am Ende seiner Lebenszeit vom Hausmüll getrennt zu entsorgen ist, und einer Müllsammelstelle für Elektro- und Elektronik-Altgeräte zugeführt, oder bei Kauf eines neuen gleichartigen Geräts dem Händler zurückgegeben werden muss.

Der Benutzer ist dafür verantwortlich, dass das Gerät am Ende seiner Nutzungsdauer zu den entsprechenden Sammelstellen gebracht wird. Die korrekte getrennte Sammlung des Geräts für seine anschließende Zuführung zum Recycling, zur Behandlung und zur umweltgerechten Entsorgung trägt dazu bei, mögliche negative Auswirkungen auf die Umwelt und auf die Gesundheit zu vermeiden und begünstigt die Wiederverwertung der Werkstoffe des Produkts. Für genauere Informationen über die verfügbaren Sammelsysteme wenden Sie sich bitte an den örtlichen Müllsammeldienst oder an den Händler, bei dem Sie das Gerät gekauft haben.

### Risikos, die als gefährlichen gehaltenen Stoffen entsprechen (WEEE).

Gemäss die Richtlinien WEEE, Stoffe, die bei elektrischen und elektronischen Anlagen schon lange verwendet werden, wie gefährlich für die Personen und für die Umwelt behalten werden müssen. Die angemessene unterschiedene Sammlung für die folgende Übertragung des für den Abfall, Behandlung und Verdauung abgelegten Gerätes kompatibel der Umwelt hilft mögliche negative Wirkungen zu vermeiden über die Umwelt und die Gesundheit und begünstigt das Recycling vom Materialen, deren der Produkt hergestellt ist.

## 2. Allgemeine Sicherheitshinweise

### Bitte unbedingt lesen!

#### Zielgruppe

Dieses Antriebssystem darf nur von qualifiziertem und geschultem Fachpersonal montiert, angeschlossen und in Betrieb genommen werden!. Qualifiziertes und geschultes Fachpersonal im Sinne dieser Beschreibung sind Personen.

- mit Kenntnis der allgemeinen und speziellen Sicherheits- und Unfallverhütungsvorschriften,
- mit Kenntnis der einschlägigen elektrotechnischen Vorschriften,
- mit Ausbildung in Gebrauch und Pflege angemessener Sicherheitsausrüstung,
- mit ausreichender Unterweisung und Beaufsichtigung durch Elektrofachkräfte,
- mit der Fähigkeit, Gefahren zu erkennen, die durch Elektrizität verursacht werden können,
- mit Kenntnis in der Anwendung der EN 12635 (Anforderungen an Installation und Nutzung).

#### Gewährleistung

Für eine Gewährleistung in Bezug auf Funktion und Sicherheit müssen die Hinweise in dieser Anleitung beachtet werden.

Bei Missachtung der Warnhinweise können Körperverletzungen und Sachschäden auftreten.

Für Schäden, die durch Nichtbeachtung der Hinweise eintreten, haftet der Hersteller nicht.

Von der Gewährleistung ausgeschlossen sind Batterien, Sicherungen und Glühlampen.

Um Einbaufehler und Schäden an Tor und Antriebssystem zu vermeiden, ist unbedingt nach den Montageanweisungen der Einbauanleitung vorzugehen.

Das Produkt darf erst nach Kenntnisnahme der zugehörigen Einbau- und Bedienungsanleitung betrieben werden.

Die Einbau- und Bedienungsanleitung ist dem Betreiber der Toranlage zu übergeben und aufzubewahren. Sie beinhaltet wichtige Hinweise für Bedienung, Prüfung und Wartung.

Das Produkt wird gemäß den in der Hersteller- und Konformitäts-erklärung aufgeführten Richtlinien und Normen gefertigt.

Das Produkt hat das Werk in sicherheitstechnisch einwandfreiem Zustand verlassen.

Kraftbetätigte Fenster, Türen und Tore müssen vor der ersten Inbetrieb-

nahme und nach Bedarf, jedoch jährlich mindestens einmal von einem Sachkundigen geprüft werden (mit schriftlichem Nachweis).

#### Bestimmungsgemäße Verwendung

Das Antriebssystem ist ausschließlich für das Öffnen und Schließen von Garagentoren bestimmt.

Der Betrieb ist nur in trockenen Räumen zulässig.

Die maximale Zug- und Druckkraft muss beachtet werden.

#### Toranforderungen

Das Tor muss:

- in Selbsthaltung stehen bleiben (durch Federausgleich),
- leicht laufen.

**Neben den Hinweisen in dieser Anleitung sind die allgemein gültigen Sicherheits- und Unfallvorschriften zu beachten! Es gelten unsere Verkaufs- und Lieferbedingungen.**

#### Hinweise zum Einbau des Antriebssystems

- Stellen Sie sicher, dass sich das Tor mechanisch in einem guten Zustand befindet.
- Stellen Sie sicher, dass das Tor in jeder Position stehen bleibt.
- Stellen Sie sicher, dass sich das Tor leicht in Richtung AUF und ZU bewegen lässt.
- Stellen Sie sicher, dass das Tor richtig öffnet und schließt.
- Entfernen Sie alle nicht benötigten Bauteile vom Tor (z. B. Seile, Ketten, Winkel etc.).
- Setzen Sie alle Einrichtungen außer Betrieb, die nach der Montage des Antriebssystems nicht benötigt werden.
- Vor Verkabelungsarbeiten trennen Sie das Antriebssystem unbedingt von der Stromversorgung. Stellen Sie sicher, dass während der Verkabelungsarbeiten die Stromversorgung unterbrochen bleibt.
- Beachten Sie die örtlichen Schutzbestimmungen.
- Verlegen Sie die Netz- und Steuerleitungen unbedingt getrennt. Die Steuerspannung beträgt 24 V DC.
- Montieren Sie das Antriebssystem nur bei geschlossenem Tor.
- Montieren Sie alle Impulsgeber und Steuerungen einrichtungen (z. B. Funkcodetaster) in Sichtweite des Tores und in sicherer Entfernung zu beweglichen Teilen des Tores. Eine Mindestmontagehöhe von 1,5 Metern muss eingehalten werden.
- Bringen Sie die Warnschilder gegen Einklemmen an auffälligen Stellen dauerhaft an.
- Stellen Sie sicher, dass nach der Montage keine Teile des Tores in öffentliche Fußwege oder Straßen hineinragen.

#### Hinweise zur Inbetriebnahme des Antriebssystems

Die Betreiber der Toranlage oder deren Stellvertreter müssen nach Inbetriebnahme der Anlage in die Bedienung eingewiesen werden.

- Stellen Sie sicher, dass Kinder nicht mit der Torsteuerung spielen können.
  - Stellen Sie vor Bewegung des Tores sicher, dass sich keine Personen oder Gegenstände im Gefahrenbereich des Tores befinden.
  - Prüfen Sie alle vorhandenen Not-Befehleinrichtungen.
  - Greifen Sie niemals in ein laufendes Tor oder bewegte Teile.
  - Achten Sie auf mögliche Quetsch- und Scherstellen an der Toranlage.
- Die Bestimmungen der EN 13241-1 müssen beachtet werden. Hinweise zur Wartung des Antriebssystems
- Um eine störungsfreie Funktion zu gewährleisten, müssen die folgenden Punkte regelmäßig kontrolliert und gegebenenfalls in Stand gesetzt werden. Vor Arbeiten an der Toranlage ist das Antriebssystem immer spannungslos zu schalten.
- Überprüfen Sie jeden Monat, ob das Antriebssystem reversiert, wenn das Tor ein Hindernis berührt. Stellen Sie dazu, entsprechend der Laufrichtung des Tores, ein 50 mm hohes/breites Hindernis in den Torlaufweg.
  - Überprüfen Sie die Einstellung der Abschaltautomatik AUF und ZU.
  - Überprüfen Sie alle beweglichen Teile des Tor- und Antriebssystems.
  - Überprüfen Sie die Toranlage auf Verschleiß oder Beschädigung.
  - Überprüfen Sie die Leichtgängigkeit des Tores von Hand.

#### Hinweise zur Reinigung des Antriebssystems

Auf keinen Fall dürfen zur Reinigung eingesetzt werden: direkter Wasserstrahl, Hochdruckreiniger, Säuren oder Laugen.

### 3. Technische Daten EN05, EN10

#### Elektrische Daten

	EN05	EN10
- Nennspannung	230 V	230 V
- Nennfrequenz	50 Hz	50 Hz
- Stromaufnahme	0,7 A	0,7 A
- Leistungsaufnahme Betrieb	0,2 KW	0,26 KW
- Leistungsaufnahme Stand-by	< 3,9 W	< 3,9 W
- Betriebsart (Einschaltdauer)	KB 2 Min.	KB 2 Min.
- Steuerspannung	24 V DC	24 V DC
- Schutzart Motor-Aggregat	IP 20	IP 20
- Schutzklasse	II	II

#### Mechanische Daten

- Max. Zug- und Druckkraft	500 N	100 N
- Laufgeschwindigkeit	140 mm/Sek.	140 mm/Sek.
- Öffnungszeit (torspezifisch) ca.	15 Sek.	15 Sek.

#### Umgebungsdaten

- Abmessungen Motor-Aggregat	160x215x395 mm	160x215x395 mm
- Gewicht	5,90 kg	6,70 kg
- Temperaturbereich	-20 bis +60 °C	-20 bis +60 °C

#### Lieferumfang

- Motor-Aggregat EN05 mit integrierter elektronischer Steuerung
- Modulantenne Eigenschaften/Sicherheitsfunktionen
- Referenzpunkt-Technik
- Soft-Start / Soft-Stopp
- Aufschubsicherung
- Abschaltautomatik
- Blockierschutz
- Unterspannungsschutz
- Laufzeitbegrenzung
- Elektronische Endabschaltung
- Anschluss für Druck-, Code- und Schlüsseltaster
- Anschluss potenzialfreie Endtastermeldung
- Fehlersignalisierung



## 4. Produktübersicht

### 4.1 Lieferumfang EN05, EN10

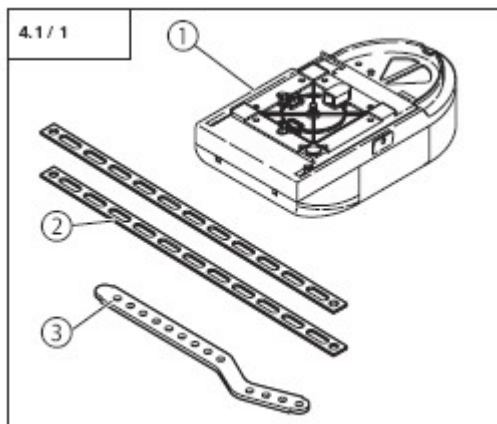

- 1- Motor-Aggregat EN05, EN10  
 2- Abhängungsblech  
 3- Tormitnehmer

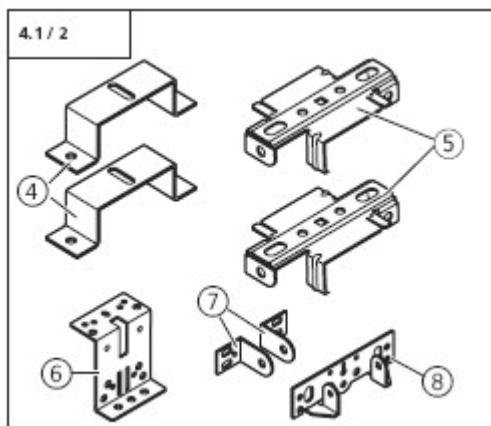

- 4- Schienenklemme (2x)  
 5- Abhängungsklammer (2x)  
 6- Toranschlusselement  
 7- Tormitnehmerwinkel (2x)  
 8- Sturzanschlussblech

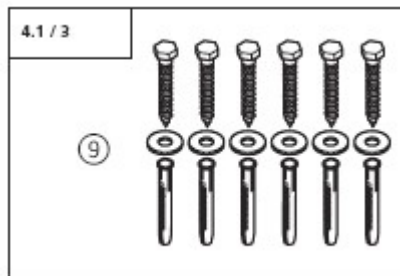

- 9- Befestigungsmaterial Schiene

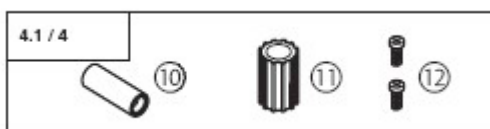

- 10- Sicherungshülse  
 11- Adapterhülse  
 12- Schraube 4,0 x 10 (2x)

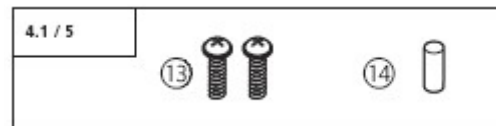

- 13- Schraube 4,0 x 18 (2x)  
 14- Bolzen 8 x 20

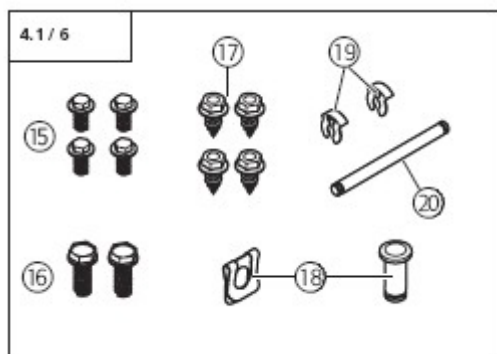

- 15- Schraube 6 x 14 (4x)  
 16- Sechskantschraube M6 x 20 (2x)  
 17- Blechschrauben 6,3 x 16 (4x)  
 18- Bolzen A8 mit SL-Sicherung  
 19- Sicherungsclips (2x)  
 20- Gelenkbolzen  $\varnothing$  6

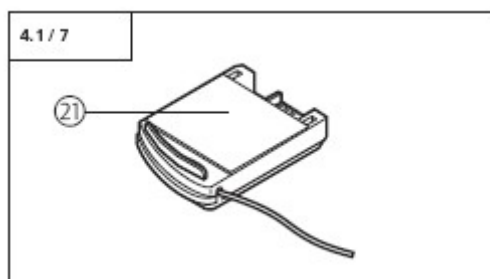

- 21- Modulantenne

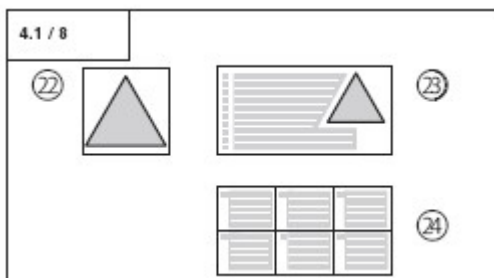

- 22- Warnschild Entriegelung  
 23- Warnaufkleber  
 24- Aufkleber Schnellprogrammierung  
 Neben dem Standard-Lieferumfang ist folgendes Zubehör für die Montage erforderlich:  
 - Antriebsschiene

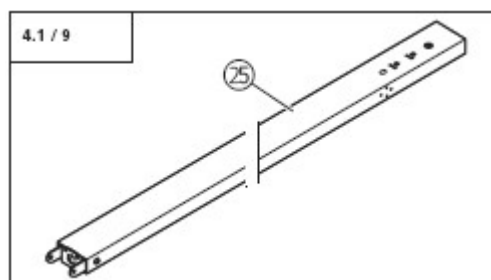

#### Antriebsschienen

Das Motor-Aggregat kann mit unterschiedlichen Antriebsschienen kombiniert werden.

- 25- Antriebsschiene

## 4.2 Torvarianten

Der Standard-Lieferumfang mit entsprechender Antriebsschiene ist für folgende Torvarianten geeignet.

### Ausschwingendes Kipptor (Schwingtor)

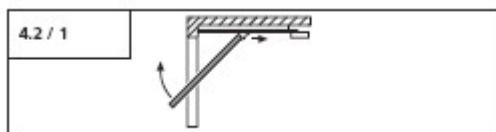

### Sektionaltor bis 3 m Breite

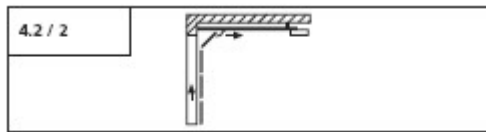

Für die nachfolgende Torvariante ist Sonderzubehör erforderlich.

### Nicht ausschwingendes Kipptor

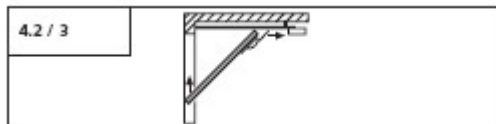

## TABELLE MIT EMPFEHLUNGEN FÜR DIE WAHL DES MODELLS DER SCHLEPPANTRIEBE EN05 – EN10 AN SEKTIONALTOREN IM WOHNBE- REICH

### ACHTUNG: GRUNDVORAUSSETZUNG IST DIE PERFEKTE BALANCE DES SEKTIONALTORS.

Vorgesehener Einsatz im Wohnbereich, für Garagentore von Ein- oder Zweifamilienhäusern. Wenn die Türen als Zugang zu einer intensiv genutzten Mehrparteiengarage dienen, wird der Art. EN10 empfohlen.

H: Türhöhe

L: Türbreite

Führung	H/L (mm)	2.000	2.500	3.000	3.500	4.000	4.500	5.000	5.500	6.000
<b>EN11</b>	2.250	EN05	EN05	EN05	EN05	EN05	EN10	EN10	EN10	EN10
<b>EN12</b>	2.500	EN05	EN05	EN05	EN05	EN10	EN10	EN10	EN10	EN10
<b>EN13</b>	3.250	EN05	EN05	EN05	EN10	EN10	EN10	EN10	EN10	EN10



### Achtung!

Um eine korrekte Montage zu gewährleisten, müssen vor Beginn der Arbeiten die folgenden Kontrollen unbedingt durchgeführt werden.

## 5. Montagevorbereitungen

### Lieferumfang

- Prüfen Sie, ob der Lieferumfang vollständig ist.
- Prüfen Sie, ob benötigte Zubehörteile für Ihre Einbausituation vorhanden sind.

### Garage

- Prüfen Sie, ob Ihre Garage einen geeigneten Stromanschluss und eine Netztrenneinrichtung besitzt.

### Toranlage



### Achtung!

Bei Garagen ohne zweiten Eingang: Um im Falle einer Störung die Garage betreten zu können, muss das Garagentor mit einer Notentriegelung ausgestattet werden.

Wenn ein Entriegelungsset verwendet wird:

- Überprüfen Sie die korrekte Funktion der Torverschlüsse. Die Torverschlüsse dürfen auf keinen Fall außer Funktion gesetzt werden.

Wenn **kein** Entriegelungsset verwendet wird:

- Bauen Sie die Torverschlüsse ab oder setzen Sie die Torverschlüsse außer Funktion.

- Prüfen Sie, ob das anzutreibende Tor die folgenden Bedingungen erfüllt:

- Das Tor muss sich von Hand leicht bewegen lassen.
- Das Tor sollte in jeder Position von selbst stehen bleiben.



**Verweis:**  
 Bei Einsatz und Montage von Zubehör ist die jeweilige beiliegende Anleitung zu beachten.

## 6. Montage

### 6.1 Montage von Motor-Aggregat und Antriebsschiene

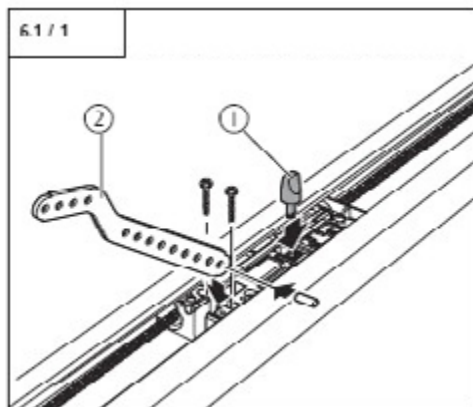

1. Entriegelungsstift einsetzen.
2. Tormitnehmer montieren.

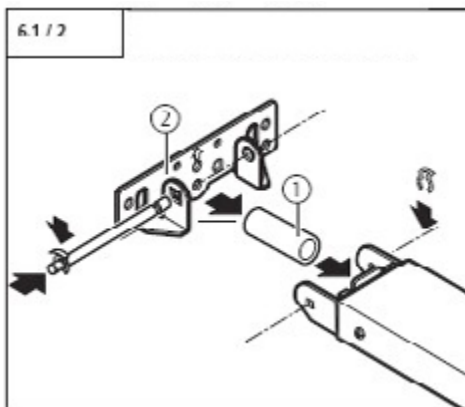

1. Sicherungshülse einsetzen.
2. Sturzanschlussblech montieren.

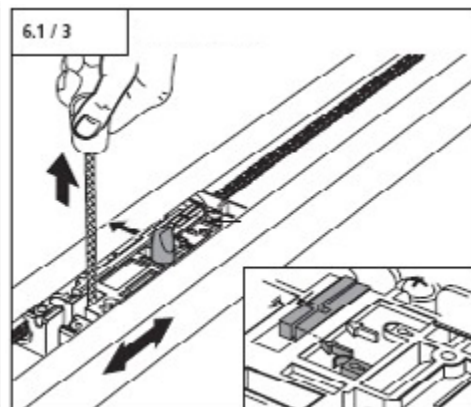

Schlitten entriegeln.

#### 6.1.1 Montage gerade



**Achtung!**

Die Antriebsschiene muss vorsichtig auf das Motor-Aggregat montiert werden. Es darf keine Gewalt angewendet werden, da sonst die Verzahnung beschädigt werden kann!

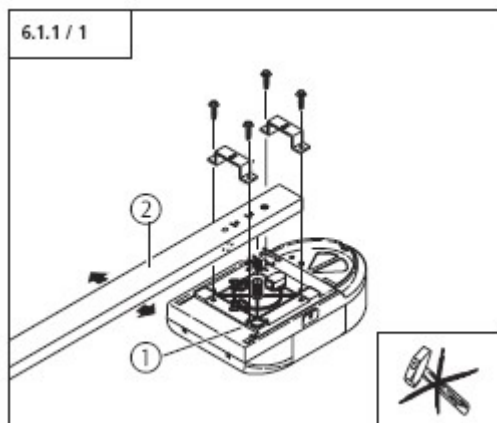

1. Adapterhülse auf Getriebewelle stecken.
2. Schiene auf Motor-Gehäuse montieren.

#### 6.1.2



**Achtung!**

- Die Antriebsschiene muss vorsichtig auf das Motor-Aggregat montiert werden. Es darf keine Gewalt angewendet werden, da sonst die Verzahnung beschädigt werden kann!
- Um die Funktion des Antiebsystems zu gewährleisten, muss der Referenzpunktaster um 90° versetzt werden.

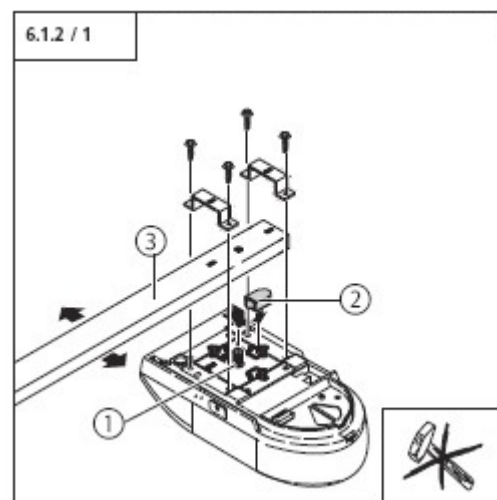

1. Adapterhülse auf Getriebewelle stecken
2. Referenzpunktaster versetzen
3. Schiene auf Motor-Gehäuse montieren.

## 6.2 Montage am Tor



### Vorsicht!

Das Antriebssystem muss bis zur Befestigung gegen Herausstürzen gesichert werden.

### Achtung!

Um einen einwandfreien Torlauf zu gewährleisten muss:

- das Sturzanschlussblech für die Antriebsschiene mittig über dem Toranschlusselment montiert werden.
- die Torblattoberkante am höchsten Punkt der Öffnungsbahn 10-50 mm unterhalb der waagerechten Antriebsschienenunterkante liegen.

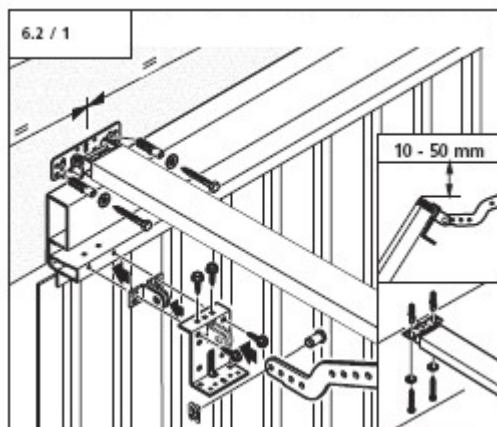

Montage am Schwingtor

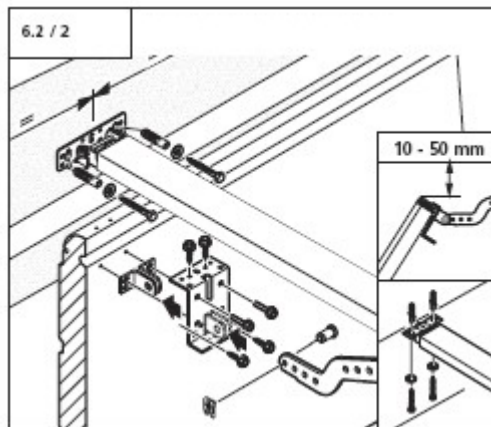

Montage am Sectionaltor

## 6.3 Montage an der Decke

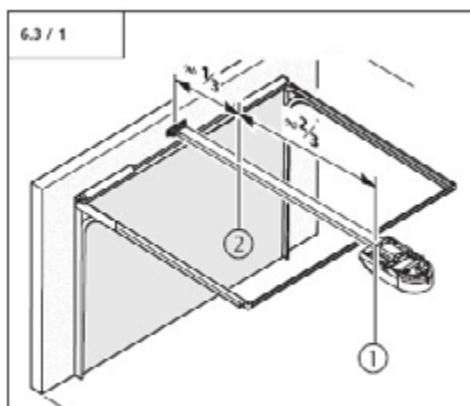

Montagepositionen 1 und 2 festlegen.

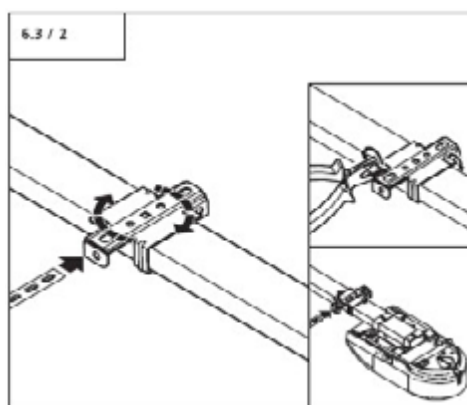

Anhängklammern an den Montagepositionen montieren.

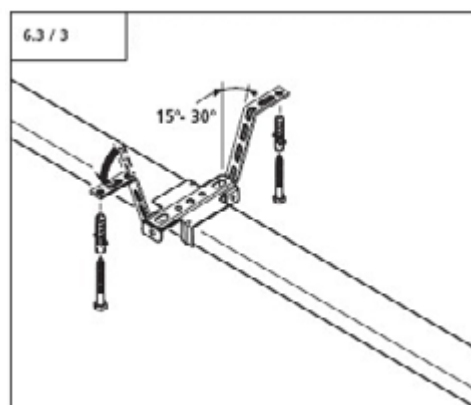

Abhängungsbleche biegen und an die Decke montieren.

## 6.4 Entriegelung



### Vorsicht!

Beim Betätigen der Entriegelung kann es zu unkontrollierten Bewegungen des Tores kommen:

- Wenn die Torfedern schwach oder gebrochen sind.
- Wenn sich das Tor nicht im Gleichgewicht befindet.

Bei Öffnen des Tores von Hand kann der Führungsschlitten mit dem Motor-Aggregat kollidieren.

Im entriegelten Zustand darf das Tor nur mit mäßiger Geschwindigkeit bewegt werden!

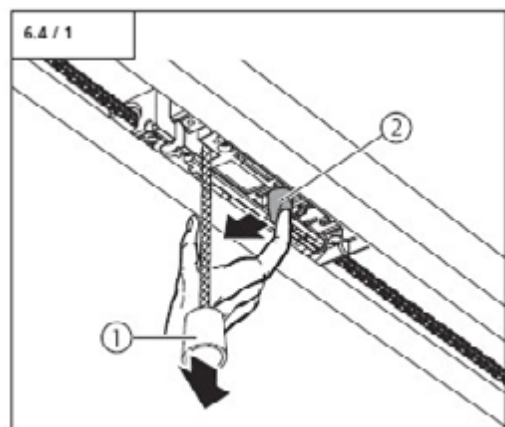

- Begrenzen Sie durch Baumaßnahmen den Torlaufweg in Aufrichtung.
- Prüfen Sie die Mindesthöhe des Zugseils von 1,8 m.
- Bringen Sie das "Warnschild Entriegelung" am Zugseil an.

1. Tör und Motor-Aggregat trennen.
2. Tör und Motor-Aggregat wieder verbinden.

## 6.5 Steuerungsanschlüsse

**Vorsicht!**  
Stromschlaggefahr:  
Vor Verkabelungsarbeiten ist sicherzustellen, dass die Leitungen spannungsfrei sind.  
Während der Verkabelungsarbeiten ist sicherzustellen, dass die Leitungen spannungsfrei bleiben (z. B. Wieder - einschalten verhindern).

**Achtung!**  
Um Schäden an der Steuerung zu vermeiden:  
- Die örtlichen Schutzbestimmungen sind jederzeit zu beachten.  
- Die Netz- und Steuerleitungen müssen unbedingt getrennt verlegt werden.  
- Die Steuerspannung beträgt 24 V DC.  
- Fremdspannung an den Anschlüssen XP020, XB10 oder XB01 führt zur Zerstörung der gesamten Elektronik.  
- An die Klemmen 1 und 2 (XB01) dürfen nur potentialfreie Schließer - kontakte angeschlossen werden.  
- Der Kurzschlussstecker darf nicht in die System-Buchse XP020 gesteckt werden!

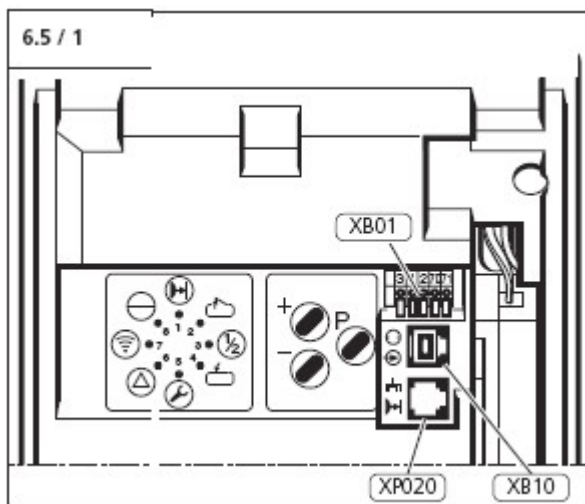

Bezeichnung	Art / Funktion	
XB01	Anschluss externer Bedien - elemente ohne System - verkabelung und Zweidraht - Lichtschanke	6.5 / 2
XB10	Nicht in Gebrauch	-
XP020	Klemme für Öffnerkontakt Der Art. EN0C (optional) dient zum Hinzufügen eines zweiten Schaltgeräts oder einer Fotozelle.	-

Anschlussmöglichkeiten.

**Verweis:**  
Für die Montage externer Bedien - elemente, Sicherheits - und Signal - einrichtungen müssen die entsprechenden Anleitungen beachtet werden.

**Hinweis:**  
Vor dem Anschluss eines Bedien - elementes an den Anschlüssen mit Systembuchsen muss der entsprechende Kurzschluss stecker entfernt werden.

**Anschluss XB01: An der Steckdose kann entweder ein externes Schaltgerät (Wahlschalter oder Taster) oder Fotozellen angeschlossen werden**

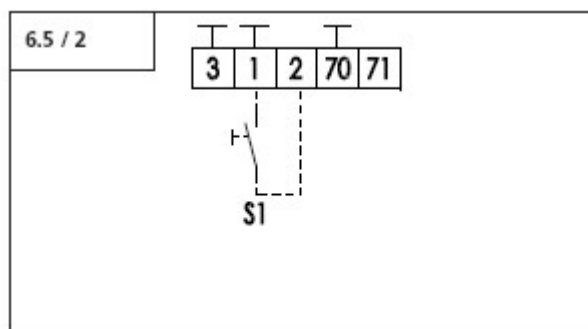

Bezeichnung	Art / Funktion	
1	Anschluss GND	
2	Programmierbarer Impulseingang	8.2 / Ebene 5
3	Anschluss + 24 V DC (max. 50 mA)	-
70	Ohne Funktion	-
71	Ohne Funktion	-
S1	Anschlussbeispiel: Externer Impulstaster	8.2 / Ebene 5

**Anschluss der ELVOX Lichtschanke an XB01**

Bezeichnung	Art / Funktion	
1	COM, -	-
2	N.C. (ÖFFNERKONTAKT)	8.2 / Ebene 5
3	-	-

**Verweis:**  
Nach Anschluss der ELVOX-Lichtschanke muss der programmierbare Impuls - eingang auf die Funktion C1 eingestellt werden (Antriebssystem stoppt und reversiert). Die Programmierung der Lichtschanke ist in Kapitel 8.2, Menü 5 beschrieben.

- Plug **XP020**: Ein zusätzlicher Öffnerkontakt ist möglich (optional), Art EN0C, um die Verwendung einer externen Steuerung (Wahlschalter oder Taster) und der Fotozellen (Versorgung 24 V) zu erhalten.

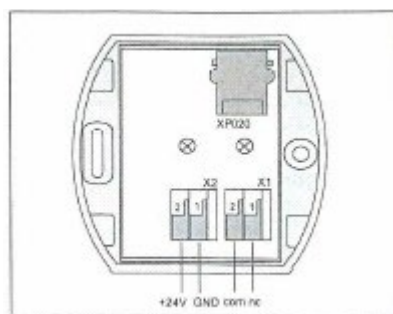

## 6.6 Anschluss der Blinkleuchte ELVOX Art. ELA3 (Anschlussspannung 230V) an der Klemme der Zufahrtsbeleuchtung



### Achtung!

Um den Isoliermantel des Stromkabels nicht zu beschädigen, muss das Kabel immer so verlegt werden, dass es nicht die Lampe der Zufahrtsbeleuchtung berührt.

- Das Gehäuse der Zufahrtsbeleuchtung abnehmen.
- Die Blinkleuchte wieder anschließen.
- Die gewünschte Funktion einstellen (Ebene 3, Menü 1).
- Das Gehäuse der Zufahrtsbeleuchtung wieder anbringen.

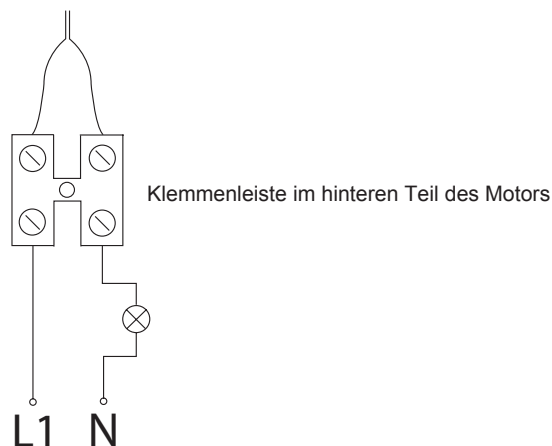

## 7. Inbetriebnahme

### 7.1 Anschluss des Antriebssystems

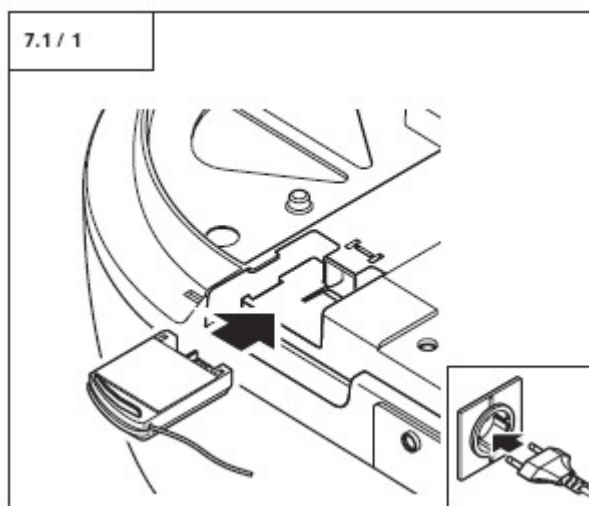

### 7.2 Übersicht der Steuerung

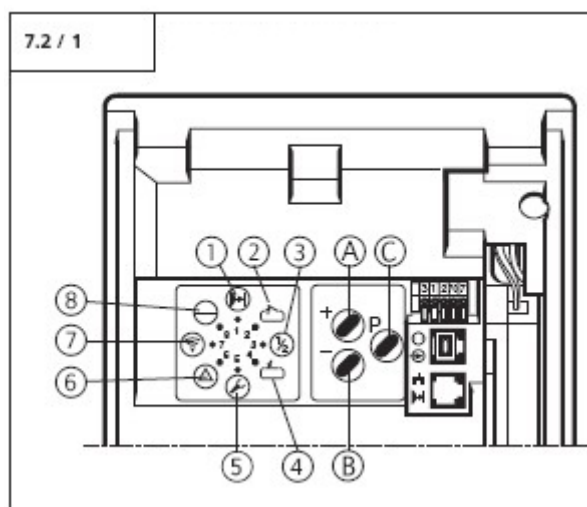

#### LED-Anzeigen

- 1- Lichtschranke (leuchtet nur, wenn die Lichtschranke unterbrochen ist)
- 2- Torposition AUF
- 3- Zwischenposition
- 4- Torposition ZU
- 5- Kontrolle Referenzpunkt
- 6- Ohne Funktion
- 7- Impulsgabe (Fernsteuerung, Externe Bedienelemente)
- 8- Betrieb





#### Bedienelemente

- A Taste (+) (z. B. Tor in Position AUF fahren oder Parameter in der Programmierung hochsetzen)  
 B Taste (-) (z. B. Tor in Position ZU fahren oder Parameter in der Programmierung herabsetzen)  
 C Taste (P) (z. B. Wechsel in Programmiermodus oder Parameter abspeichern)

## 7.3 Übersicht der Anzeigefunktionen

### LED-Anzeigen im Betriebsmodus

	Lichtschanke unterbrochen
	Tor fährt in Richtung AUF
	Tor ist in Torposition AUF
	Tor fährt in Richtung ZU
	Tor ist in Torposition ZU
	Referenzpunkt wird geschaltet
	Dauerbetätigung eines externen Bedienelements
	Fernsteuerung wird betätigt
	Betriebsspannung liegt an

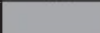
Legende:	
LED aus	
LED leuchtet	
LED blinkt langsam	
LED blinkt rhythmisch	
LED blinkt schnell	
Werkseinstellung	
Nicht möglich	-

## 7.4 Schnellprogrammierung

 **Hinweis:**  
 Zur ordnungsgemäßen Inbetriebnahme des Antriebssystems muss die Schnell - programmierung durchgeführt werden. Dieses gilt für die erste Inbetriebnahme und nach einem Reset.

### Voraussetzungen

Vor der Schnellprogrammierung müssen folgende Voraussetzungen erfüllt sein:

- Das Tor befindet sich in der Torposition ZU.
- Der Führungsschlitten ist eingekuppelt.

 **Hinweis:**  
 Während der Programmierung der Torpositionen AUF und ZU muss der Referenzpunkt passiert werden.

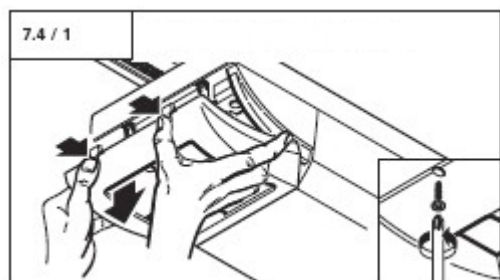

















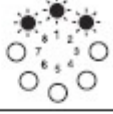





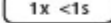

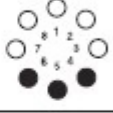

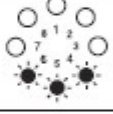

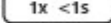

Abnehmen der Sichtblende.

**Die Programmierung erfolgt mit den Tasten Plus (+), Minus (-) und (P).**

Wird im Programmiermodus innerhalb von 120 Sekunden keine der Tasten betätigt, wechselt die Steuerung zurück in den Betriebszustand. Es wird eine entsprechende Meldung angezeigt.

 **Verweis:**  
 Die Erklärung der Meldungen ist in Punkt 9 beschrieben.

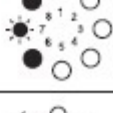
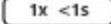
- Führen Sie die Schnellprogrammierung anhand des nachstehenden Ablaufplans durch.

 <p>Betriebs - modus</p>	1.	 	<b>Schnell programmierung starten / Torposition AUF programmieren</b>	
	2.	 	Tor in Position AUF fahren	
	3.	   	Korrektur der Torposition AUF mit (+) und (-)	
	4.	 	<b>Torposition AUF speichern / Torposition ZU programmieren</b>	
	5.	 	Tor in Position ZU fahren	
	6.	   	Korrektur der Torposition ZU mit (+) und (-)	
	7.	 	<b>Torposition ZU speichern / Fern steuerung programmieren</b>	
	8.		Handsender betätigen	
	9.		Handsender loslassen	
	10.	 	<b>Fernsteuerung speichern / Schnellprogrammierung beenden</b>	



**SCHNELLE PROGRAMMIERUNG EN05 - EN10**

1. Die Stromzufuhr zum Antrieb einschalten, während sich die Tür in Schließposition befindet. Die LED Nr. 8, die anzeigt, das der Antrieb mit Strom versorgt wird, und die LED Nr. 4, die anzeigt, dass sich die Tür in Schließposition befindet, müssen aufleuchten ○.
  
2. Um mit der schnellen Programmierung zu beginnen, die Taste P drücken, bis das obere Segment der drei LEDs Nr. 8 - Nr. 1 - Nr. 2 aufleuchtet.
  
3. Die Taste P loslassen und die Taste "+" drücken. Die Taste "+" gedrückt halten, bis die Tür vollständig geöffnet ist. Während des Öffnungsvorgangs blinken die 3 LEDs. Mit den Tasten "-" und "+" können eventuelle Korrekturen vorgenommen werden.
  
4. Die Taste P drücken, um den Öffnungsanschlag zu speichern. Das untere Segment drei roten LEDs Nr. 4 - Nr. 5 - Nr. 6 leuchtet auf.
  
5. Die Taste P loslassen und die Taste "-" drücken. Die Taste "-" gedrückt halten, bis die Tür vollständig geschlossen ist. Während des Schließvorgangs blinken die 3 LEDs. Mit den Tasten "+" und "-" können eventuelle Korrekturen vorgenommen werden.
  
6. Die Taste P drücken, um den Schließanschlag zu speichern. Die roten LEDs Nr. 6 - Nr. 7 (blinkend) - Nr. 8 leuchten auf.
  
7. Die Taste der Funksteuerung drücken. Die LED Nr. 7 zeigt durch schnelles Blinken an, dass der Code gespeichert wurde.
  
8. Die Taste P drücken, um den Funkcode zu speichern, und 1 Sekunde lang gedrückt halten. Alle LEDs leuchten nacheinander gegen den Uhrzeigersinn auf und erlöschen, der Antrieb beendet die Programmierung und kehrt zum anfänglichen Status zurück (LEDs Nr. 8 und Nr. 4 leuchten auf).
  
9. Zur Kontrolle des korrekten Betriebs die Tür durch Drücken der Taste an der Funksteuerung öffnen und wieder schließen.

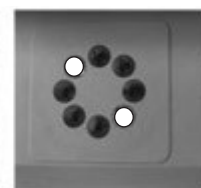
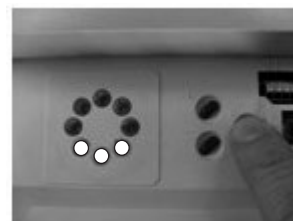
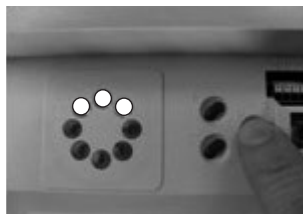
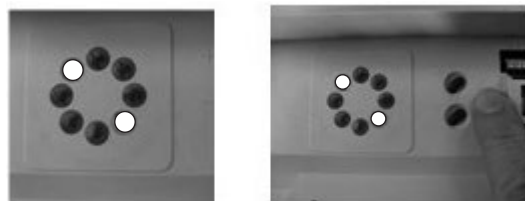

## 7.5 Funktionsprüfung

### 7.5.1 Lernfahrt für die Antriebskraft

 **Kontrolle:**  
 Nach der Schnellprogrammierung und nach Veränderungen im Programmier - modus müssen die nachfolgenden Lern fahrten und Prüfungen durchgeführt werden.

Das Antriebssystem lernt die maximal benötigte Antriebskraft während der beiden ersten Fahrten nach Einstellung der Torpositionen.

- Fahren Sie das Antriebssystem (mit eingekuppeltem Tor) ohne Unterbrechung einmal von der Torposition ZU in die Torposition AUF und zurück.

Das Antriebssystem ermittelt während dieser Lernfahrt die maximale Zug- und Druckkraft und die Kraftreserve, die erforderlich ist, um das Tor zu bewegen.

#### Überprüfung:

1.		Nach Druck auf Taste (+): Das Tor muss sich öffnen und in die eingespeicherte Torposition AUF fahren.
2.		Nach Druck auf Taste (-): Das Tor muss sich schließen und in die eingespeicherte Torposition ZU fahren.
3.		Nach Druck auf Taste des Hand-senders: Das Antriebssystem muss das Tor in Richtung AUF bzw. Richtung ZU bewegen.
4.		Nach Druck auf Taste des Hand-senders während das Antriebs-system läuft: Das Antriebs-system muss stoppen.
5.		Beim nächsten Drücken läuft das Antriebssystem in Gegen-richtung.

### 7.5.2 Kontrolle der Abschaltautomatik

 **Vorsicht!**  
 Die Abschaltautomatik AUF und ZU muss korrekt eingestellt werden, um Personen - oder Sachschäden zu verhindern.

#### Abschaltautomatik AUF

Bei Antriebssystemen für Tore mit Öffnungen im Torflügel (Durchmesser Öffnung > 50 mm):

- Belasten Sie das Tor während des Torlaufs in der Mitte der Unterkante mit einer Masse von 20 kg.

**Das Tor muss sofort stoppen.**

#### Abschaltautomatik ZU

- Stellen Sie ein 50 mm hohes Hindernis auf den Boden.
- Fahren Sie das Tor auf das Hindernis.

**Das Antriebssystem muss beim Auftreffen auf das Hindernis stoppen und reversieren.**

 **Hinweis:**  
 Die Einstellungen der Parameter bleiben bei Unterbrechung der Netzspannung gespeichert.  
 Nur durch Reset werden die Antriebs - kräfte AUF und ZU in die Werks - einstellung zurückgesetzt.

## 8. Erweiterte Antriebsfunktionen.

### 8.1 Ablaufschema der erweiterten Programmierung (Beispiel für Ebene 2, Menü 2)

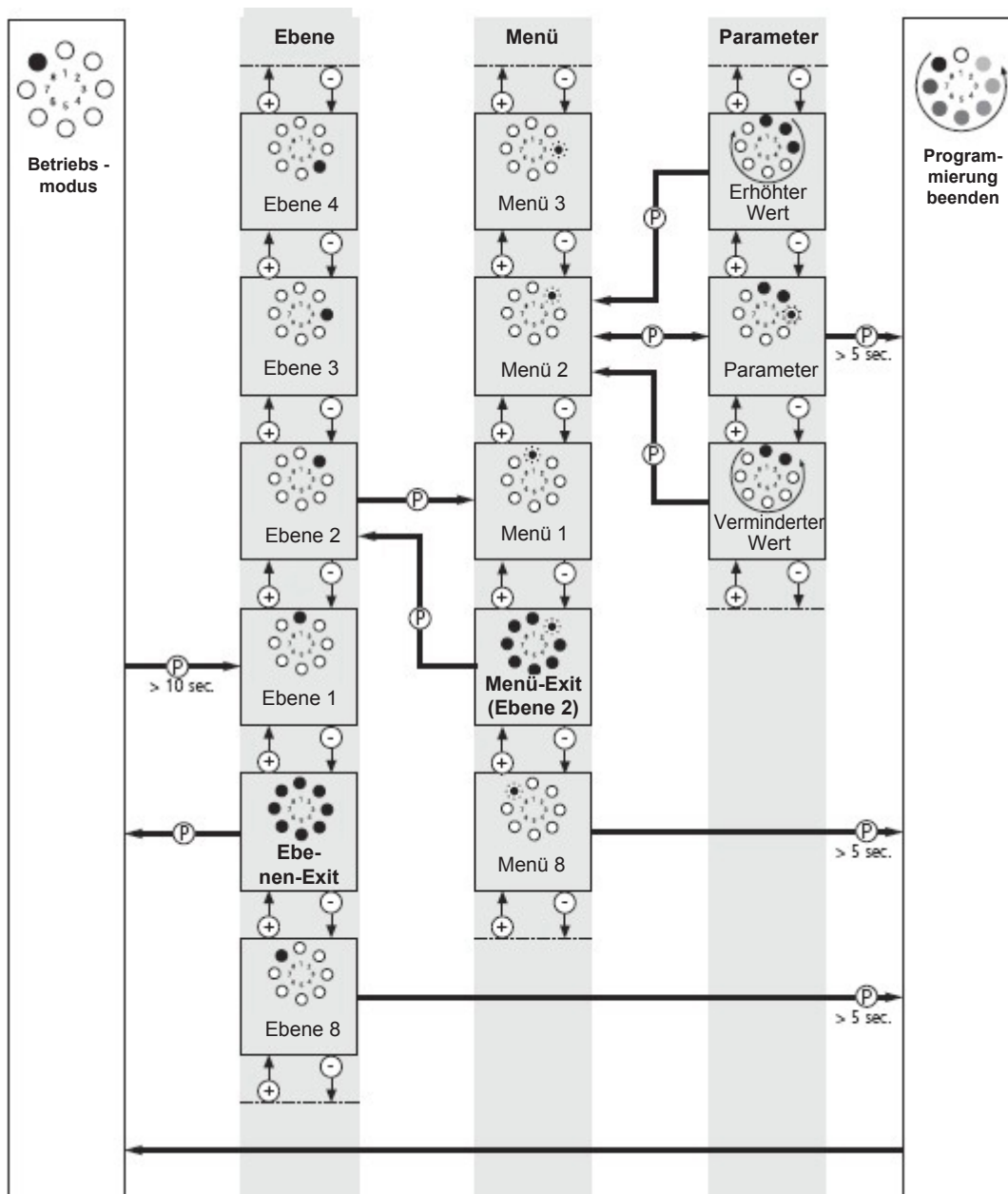

## 8.2 SCHNELLEINSTELLUNG DER ERWEITERTEN PROGRAMMIERUNGSFUNKTIONEN



1. Die Taste (P) > 10 Sek. lang drücken.
2. Warten, bis alle Leds gegen den Uhrzeigersinn erlöschen, bis zur ersten Led Ebene (1).

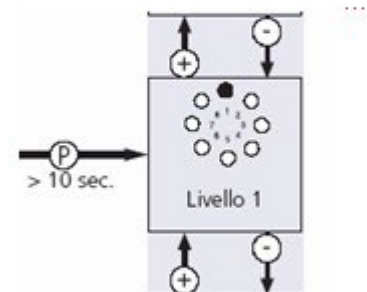

3. Die Taste (P) loslassen.
4. Mit den Tasten (+) und (-) die gewünschte Ebene wählen und die Taste (P) drücken, um das Menü der Ebene zu öffnen (die rote Led blinkt).

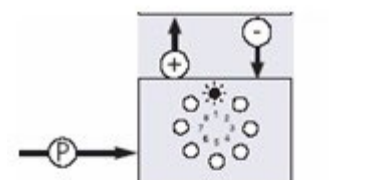

5. Mit den Tasten (+) und (-) das gewünschte Menü wählen.
6. Die Taste (P) drücken, um das Menü zu öffnen (die rote Led blinkt schnell).

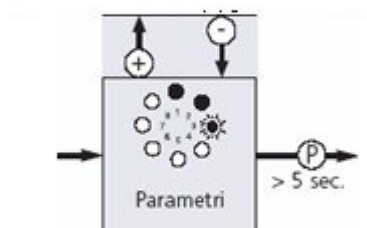

7. Durch Drücken der Tasten (+) und (-) die Funktionen oder die Werte unter Bezugnahme auf die in den Bedienungsanleitungen enthaltenen Tabellen ändern.
8. Nach Wahl des gewünschten Werts die Taste (P) >5 Sek. lang drücken und loslassen, sobald die Leds gegen den Uhrzeigersinn aufhören zu blinken.



























Die Programmierung beenden.

### 8.3 Funktionsübersicht der Ebenen



**Vorsicht!**

In den erweiterten Antriebsfunktionen können wichtige Werks ein stellungen verändert werden. Die einzelnen Parameter müssen korrekt ein- gestellt werden, um Personen- oder Sachschäden zu verhindern.

Ebene 1 - Grundfunktionen																
	1	2	3	4	5	6	7	8	9	10	11	12	13	14	15	16
																
	<b>Menü 3: Zwischenposition AUF</b> Mit Taste (+ / AUF) und (- / ZU) einstellen "Zwischenposition AUF" – Schließfunktion ist mit automatischem Zulauf möglich															
	<b>Menü 4: Zwischenposition ZU</b> Mit Taste (+ / AUF) und (- / ZU) einstellen															
	<b>Menü 5: Softlaufposition AUF</b> Mit Taste (+ / AUF) und (- / ZU) einstellen															
	<b>Menü 6: Softlaufposition ZU</b> Mit Taste (+ / AUF) und (- / ZU) einstellen															
	<b>Menü 7: Relais -Ausgang</b>															
	A7	B7	C7	D7	E7	F7	G7	H7	-	-	-	-	-	-	-	
	<b>Menü 8: Reset</b>															
	No	Si	-	-	-	-	-	-	-	-	-	-	-	-	-	



**Achtung!**

Nach einem Reset werden alle Parameter auf die Werkseinstellungen zurückgestellt.

Um einen einwandfreien Betrieb der Steuerung zu gewährleisten:

- müssen alle gewünschten Funktionen neu programmiert werden,
- muss die Fernsteuerung eingelernt werden,
- muss das Antriebssystem einmal in die Torposition AUF und ZU gefahren werden.



**Hinweis:**

- Es kann nur die zuletzt programmierte Zwischenposition genutzt werden.
- Bei aktiviertem automatischem Zulauf (Ebene 3 / Menü 1) ist der Relais-Ausgang (Ebene 1 / Menü 7) nicht programmierbar.



**Verweis:**

Nach Veränderungen in den Menüs 3 bis 6 der Ebene 1 muss eine erneute Lernfahrt für die Abschaltautomatik durchgeführt werden. Die Lernfahrt wird in Punkt 7.5.1 beschrieben.

**Menü 7: Relais-Ausgang**

- A7- Antriebssystem läuft / Signalleuchte leuchtet
- B7- Antriebssystem läuft / Signalleuchte blinkt
- C7- 3-min.-Licht
- D7- Wischimpuls
- E7- Störung
- F7- Aufschubsicherung
- G7- Torposition ZU
- H7- Torposition AUF

Ebene 2 - Antriebseinstellungen																
	1	2	3	4	5	6	7	8	9	10	11	12	13	14	15	16
Menü 1: Benötigte Antriebskraft AUF (Empfindlichkeit in Stufen*)																
	1	2	3	4	5	6	7	8	9	10	11	12	13	14	15	16
Menü 2: Benötigte Antriebskraft ZU (Empfindlichkeit in Stufen*)																
	1	2	3	4	5	6	7	8	9	10	11	12	13	14	15	16
Menü 3: Abschaltautomatik AUF (Empfindlichkeit in Stufen**)																
	AUS	2	3	4	5	6	7	8	9	10	11	12	13	14	15	16
Menü 4: Abschaltautomatik ZU (Empfindlichkeit in Stufen**)																
	AUS	2	3	4	5	6	7	8	9	10	11	12	13	14	15	16
Menü 5: Geschwindigkeit AUF (in Stufen)																
	1	2	3	4	5	6	7	8	9	10	11	12	13	14	15	16
Menü 6: Geschwindigkeit ZU (in Stufen)																
	1	2	3	4	5	6	7	8	9	10	11	12	13	14	15	16
Menü 7: Geschwindigkeit Softlauf AUF (in Stufen)																
	1	2	3	4	5	6	7	8	9	10	11	12	13	14	15	16
Menü 8: Geschwindigkeit Softlauf ZU (in Stufen)																
	1	2	3	4	5	6	7	8	9	10	11	12	13	14	15	16

\* je höher die Stufe, desto höher die Antriebskraft.

\*\* je niedriger die Stufe, desto empfindlicher die Abschaltautomatik.



**Vorsicht!**

Um eine Verletzungsgefahr auszuschließen, darf die Abschaltautomatik (Menü 3 und 4) nur auf AUS programmiert werden, wenn eine Durchfahrts-Lichtschranke oder eine Schließkantensicherung angeschlossen ist.



**Verweis:**

Nach Veränderungen in den Menüs 5, 6, 7 und 8 der Ebene 2 muss eine erneute Lernfahrt für die Abschaltautomatik durchgeführt werden. Die Lernfahrt wird in Punkt 7.5.1 beschrieben.

Ebene 3 - Automatischer Zulauf																
	1	2	3	4	5	6	7	8	9	10	11	12	13	14	15	16
Menü 1: Automatischer Zulauf)																
	A1	B1	C1	D1	E1	F1	G1	H1	I1	-	-	-	-	-	-	-
Menü 3: Toraufzeit (in Sekunden)																
	2	5	10	15	20	25	30	35	40	50	80	100	120	150	180	255
Menü 4: Vorwarnzeit (in Sekunden)																
	1	2	5	10	15	20	25	30	35	40	45	50	55	60	65	70
Menü 5: Anfahrwarnung (in Sekunden)																
	0	1	2	3	4	5	6	7	-	-	-	-	-	-	-	-



**Hinweis:**

- Der Automatische Zulauf kann nur programmiert werden, wenn eine Lichtschranke oder eine Schließkantensicherung angeschlossen ist.
- Die Funktionen aus Menü 1 können beliebig durch die Zeitwerte in den Menüs 3, 4 und 5 verändert werden.

### Menu 1: Automatischer Zulauf

	Toraufzeit	Vorwarnzeit	Signalleuchte	sonstige Funktionen
A1	-	-	-	Richiusura automatica disattivata
B1	15	5	blinkt	-
C1	30	5	blinkt	-
D1	15	5	blinkt	Schließen nach Durchfahren der Lichtschanke
E1	30	5	blinkt	Schließen nach Durchfahren der Lichtschanke
F1	15	5	leuchtet	-
G1	30	5	leuchtet	-
H1	15	5	leuchtet	Schließen nach Durchfahren der Lichtschanke
I1	30	5	leuchtet	Schließen nach Durchfahren der Lichtschanke

### Ebene 4 - Funkprogrammierung



#### Menü 1: Impuls



LED 7 blinkt langsam -> Taste Handsender betätigen -> LED 7 blinkt schnell

#### Menü 2: Zwischenposition



LED 7 blinkt langsam -> Taste Handsender betätigen -> LED 7 blinkt schnell

### Ebene 5 - Sonderfunktion

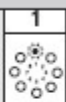
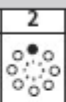
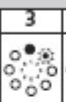
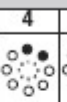
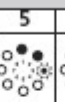
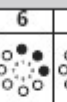
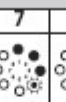
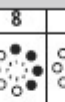
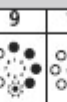
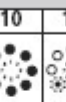
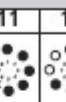
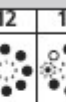
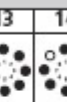
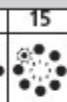
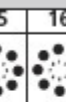
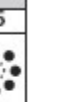
	1	2	3	4	5	6	7	8	9	10	11	12	13	14	15	16
																

#### Menü 1: Programmierbarer Impulseingang – Klemme 1/2

	A1	B1	C1	D1	E1	-	-	-	-	-	-	-	-	-	-	-
--	----	----	----	----	----	---	---	---	---	---	---	---	---	---	---	---

#### Menü 4: Beleuchtungszeit (in Sekunden)

		5	10	15	20	25	30	35	40	50	80	100	120	150	180	255
--	--	---	----	----	----	----	----	----	----	----	----	-----	-----	-----	-----	-----

### Menu 1: Contatto programmabile in input – morsetti 1/2

A1 Impuls (nur Schließer)



B1 Automatik Ein/Aus (nur Schließer)

C1 Antriebssystem stoppt und reversiert (nur Richtung ZU – nur Öffner / für die Programmierung der Elvox-Lichtschanke)

D1 Impuls AUF (Induktionsschleife – nur Schließer)

E1 Halt (nur Öffner)

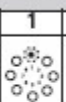
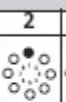
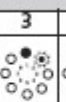
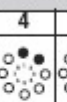
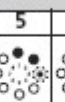
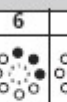
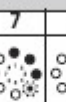
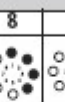
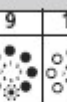
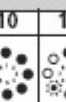
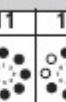
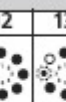
### Ebene 8 - Systemeinstellungen

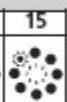
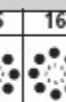
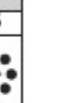
	1	2	3	4	5	6	7	8	9	10	11	12	13	14	15	16
																

#### Menü 1: Lichtschanke

	A1	B1			-	-	-	-	-	-	-	-	-	-	-	-
--	----	----	--	--	---	---	---	---	---	---	---	---	---	---	---	---

### Menü 1: Lichtschanke (nur Version mit Testung)

A1 Betrieb ohne Lichtschanke

B1 Betrieb mit System-Lichtschanke (XP020)

## 9. Meldungen







### 9.1 Störungen ohne Störmeldeanzeige



Störung	Ursache	Behebung
Anzeige 8 leuchtet nicht.	- Spannung fehlt.	- Prüfen, ob Netzspannung vorhanden ist. - Stromanschluss prüfen.
	- Thermoschutz im Netztrafo hat angesprochen.	- Netztrafo auskühlen lassen.
	- Steuerungseinheit defekt.	- Antriebssystem überprüfen lassen.
Keine Reaktion nach Impuls-gabe.	- Anschlussklemmen für Taster "Impuls" überbrückt, z. B. durch Leitungs - kurzschluss oder Flachklemmen.	- Eventuell verkabelte Schlüsseltaster oder Innendrucktaster probeweise von Steuerungseinheit trennen (Punkt 6.5): Leitung aus Buchse XB10 ziehen, Kurzschlussstecker einstecken und Verkabelungsfehler suchen.
Keine Reaktion nach Impuls-gabe durch Handsender.	- Modulantenne nicht eingesteckt.	- Modulantenne mit Steuerungseinheit verbinden (Punkt 7.1).
	- Handsendercodierung stimmt nicht überein mit Empfängercodierung.	- Handsender erneut aktivieren (Punkt 7.4).
	- Batterie des Handsenders leer.	- Neue Batterie einlegen.
	- Handsender oder Steuerungselektronik oder Modulantenne defekt.	- Alle 3 Komponenten überprüfen lassen.

Legende:	
LED aus	
LED leuchtet	
LED blinkt langsam	
LED blinkt rhythmisch	
LED blinkt schnell	
Werkseinstellung	
Nicht möglich	-









## 9.2 Störungen mit Störmeldeanzeige

Störung	Ursache	Behebung
Meldung 7 	<ul style="list-style-type: none"> <li>- Nach 120 Sekunden ohne Tastenbetätigung beendet sich der Programmiermodus selbstständig.</li> <li>- Programmieren der Torpositionen AUF und ZU ohne Passieren des Referenzpunktes.</li> </ul>	
Meldung 8 	<ul style="list-style-type: none"> <li>- Referenzpunkt-Taster defekt.</li> </ul>	<ul style="list-style-type: none"> <li>- Antriebssystem überprüfen lassen.</li> </ul>
Meldung 9 	<ul style="list-style-type: none"> <li>- Drehzahlsensor-Impulse nicht vorhanden, Antriebssystem blockiert.</li> </ul>	<ul style="list-style-type: none"> <li>- Antriebssystem überprüfen lassen.</li> </ul>
Meldung 10 	<ul style="list-style-type: none"> <li>- Torlauf zu schwergängig.</li> <li>- Tor blockiert.</li> </ul>	<ul style="list-style-type: none"> <li>- Tor gangbar machen.</li> </ul>
	<ul style="list-style-type: none"> <li>- Maximale Antriebskraft zu gering eingestellt.</li> </ul>	<ul style="list-style-type: none"> <li>- Maximale Antriebskraft (Punkt 8.2 / Ebene 2 / Menü 1+2) vom Fachhändler überprüfen lassen.</li> </ul>
Meldung 11 	<ul style="list-style-type: none"> <li>- Laufzeitbegrenzung.</li> </ul>	<ul style="list-style-type: none"> <li>- Antriebssystem überprüfen lassen.</li> </ul>
Meldung 15 	<ul style="list-style-type: none"> <li>- Lichtschranke unterbrochen oder defekt.</li> </ul>	<ul style="list-style-type: none"> <li>- Hindernis beseitigen oder Lichtschranke überprüfen lassen.</li> </ul>
	<ul style="list-style-type: none"> <li>- Lichtschranke programmiert, aber nicht angeschlossen.</li> </ul>	<ul style="list-style-type: none"> <li>- Lichtschranke deaktivieren oder anschließen.</li> </ul>
Meldung 16 	<ul style="list-style-type: none"> <li>- Stromsensor für die Abschaltautomatik defekt.</li> </ul>	<ul style="list-style-type: none"> <li>- Motor-Aggregat überprüfen lassen.</li> </ul>

Störung	Ursache	Behebung
Meldung 26 	<ul style="list-style-type: none"> <li>- Unterspannung, Antriebssystem überlastet bei Einstellung max. Kraft Stufe 16.</li> </ul>	<ul style="list-style-type: none"> <li>- Externe Spannungsversorgung überprüfen lassen.</li> </ul>
Meldung 28 	<ul style="list-style-type: none"> <li>- Torlauf zu schwergängig oder unregelmäßig.</li> <li>- Tor blockiert.</li> </ul>	<ul style="list-style-type: none"> <li>- Externe Spannungsversorgung überprüfen lassen.</li> </ul>
	<ul style="list-style-type: none"> <li>- Abschaltautomatik zu empfindlich eingestellt.</li> </ul>	<ul style="list-style-type: none"> <li>- Abschaltautomatik vom Fachhändler überprüfen lassen (Punkt 8.2 / Ebene 2 / Menü 3+4).</li> </ul>
Meldung 35 	<ul style="list-style-type: none"> <li>- Elektronik defekt.</li> </ul>	<ul style="list-style-type: none"> <li>- Antriebssystem überprüfen lassen.</li> </ul>
Meldung 36 	<ul style="list-style-type: none"> <li>- Kurzschlussstecker entfernt, Halt-Taste jedoch nicht angeschlossen.</li> <li>- Ruhestromkreis unterbrochen.</li> </ul>	<ul style="list-style-type: none"> <li>- Halt-Taste anschließen oder Kurzschlussstecker (Punkt 6.5) einstecken.</li> </ul>

### Legende:

LED aus	
LED leuchtet	
LED blinkt langsam	
LED blinkt rhythmisch	
LED blinkt schnell	
Werkseinstellung	
Nicht möglich	-

## Índice

1.	Explicación de los símbolos .....	80
2.	Indicaciones generales de seguridad.....	81
3.	Datos técnicos EN05, EN10.....	82
4.	Sinopsis del producto.....	83
4.1	Volumen de suministro EN05, EN10.....	83
4.2	Variantes de puerta .....	84
5.	Preparativos para el montaje .....	84
6.	Montaje .....	85
6.1	Montaje del bloque motor y del carril de operación .....	86
6.2	Montaje en puerta .....	87
6.3	Montaje al techo.....	87
6.4	Desbloqueo .....	87
6.5	Conexiones del control.....	88
6.6	Conexión de la luz de destellos ELVOX Art. ELA3 (alimentación 230V) al borne de la luz de cortesía.....	89
7.	Puesta en funcionamiento.....	89
7.1	Conexión del automatismo.....	89
7.2	Sinopsis del control.....	89
7.3	Sinopsis de las funciones de indicación.....	89
7.4	Programación rápida.....	90
7.5	Comprobación del funcionamiento .....	92
8.	Funciones ampliadas de operación.....	93
8.1	Esquema secuencial de la programación ampliada (Ejemplo para nivel 2, menú 2).....	93
8.2	Configuración rápida de las funciones avanzadas de programación.....	94
8.3	Sinopsis de funciones de los niveles.....	95
9.	Avisos.....	98
9.1	Fallos sin indicación.....	98
9.2	Fallos con indicación.....	99

## 1. Explicación de los símbolos

### Advice



**¡Precaución!**  
**¡Peligro de daños a personas!**  
Aquí aparecen indicaciones importantes de seguridad que tienen que ser observadas de modo estrictamente necesario con objeto de evitar daños personales.



**¡Atención!**  
**¡Peligro de daños materiales!**  
Aquí aparecen indicaciones importantes de seguridad que tienen que ser observadas de modo estrictamente necesario con objeto de evitar daños materiales.



**Indicación / Consejo**



**Controles**



**Referencia**



#### Directiva 2002/96/CE (WEEE, RAEE)

El símbolo del cubo de basura tachado, presente en el aparato, indica que éste, al final de su vida útil, no debe desecharse junto con la basura doméstica sino que debe llevarse a un punto de recogida diferenciada para aparatos eléctricos y electrónicos o entregarse al vendedor cuando se compre un aparato equivalente.

El usuario es responsable de entregar el aparato a un punto de recogida adecuado al final de su vida. La recogida diferenciada de estos residuos facilita el reciclaje del aparato y de sus componentes, permite su tratamiento y eliminación de forma compatible con el medio ambiente y previene los efectos negativos en la naturaleza y la salud de las personas. Si desea obtener más información sobre los puntos de recogida, contacte con el servicio local de recogida de basura o con la tienda donde adquirió el producto.

#### Riesgos conectados a sustancias consideradas peligrosas (WEEE).

Según la Directiva WEEE, sustancias que desde tiempo son utilizadas comunemente en aparatos eléctricos ed electrónicos son consideradas sustancias peligrosas para las personas y el ambiente. La adecuada colección diferenciada para el siguiente envío del aparato destinado al reciclaje , tratamiento y eliminación ambientalmente compatible contribuye a evitar posibles efectos negativos sobre el ambiente y la salud y favorece el reciclaje de los materiales que componen el producto.

Las informaciones siguientes de seguridad son partes integrantes y esenciales del producto y deben ser consignadas al utilizador. leerlas atentamente pues dan importantes indicaciones concernientes la instalación, el uso y la manutención. La instalación errónea o el uso impropio del producto puede ser fuente de grave peligro.

#### IMPORTANTE - INFORMACIONES CONCERNIENTES LA SEGURIDAD

- La instalación debe ser efectuada por personal profesionalmente competente y conforme a la legislación nacional y europea en vigor.
- Después de quitar el embalaje asegurarse de la integridad del aparato; en caso de duda contactar personal calificado.
- Los elementos del embalaje (cartón, bolsos en plástico, grapas, poliestirol etc. ) deben ser reciclados en contenedores apropiados, no deben ser dejados en el ambiente y sobre todo no deben ser dejados al alcance de los niños.
- La puesta en obra, el conexionado eléctrico y las regulaciones deben ser hechas correctamente, controlando que los datos de la placa sean conformes a los de la red eléctrica y verificar que la sección de los cables del conexionado sea adecuada a las cargas aplicadas; en caso de duda contactar personal calificado.
- No instalar el producto en ambientes con peligro de explosión o estorbados por campos electromagnéticos. La presencia de gases o humos inflamables constituye un grave peligro para la seguridad.
- Prever en la red de alimentación una protección para las extratensiones: un interruptor/aislador y/o diferencial adecuados al producto y en conformidad con las normas en vigor.
- Indicar claramente con una tarjeta colocada en la reja, puerta, cierre enrollable o barrera que la automatización es mandada a distancia.
- ELVOX S.p.A declina toda responsabilidad por eventuales daños causados por la instalación errónea de dispositivos y/o componentes y que no son conformes a los fines de la integridad, seguridad y funcionamiento del producto.
- El aparato debe ser destinado solamente para el uso por el cual fue concebido, toda otra aplicación debe ser considerada impropia y por tanto peligrosa.
- Antes de efectuar cualquier operación de limpieza o de manutención, desconectar el aparato de la red, sacando el enchufe o apagando el interruptor de la instalación. Para la reparación o sustitución de las partes dañadas, tendrán que utilizarse exclusivamente repuestos originales.
- El instalador debe proveer todas las informaciones relativas al funcionamiento, a la manutención y al uso de las partes individuales y del sistema en su totalidad.

## 2. Indicaciones generales de seguridad

### ¡Por favor, lea lo siguiente en cualquier caso!

¡Este automatismo tiene que ser montado, conectado y puesto en funcionamiento exclusivamente por especialistas cualificados e instruidos!

Especialistas cualificados e instruidos, en el sentido de estas instrucciones, son personas

- con conocimiento de las prescripciones generales y especiales de seguridad y de prevención de accidentes,
- con conocimiento de las prescripciones electrotécnicas pertinentes,
- con formación en el uso y el cuidado de los equipamientos adecuados de seguridad,
- con una instrucción y dirección suficiente por parte de electricistas profesionales,
- con la capacidad de reconocer los peligros que pueden ser causados por la electricidad,
- con conocimientos de la aplicación práctica de EN 12635 (Requerimientos a la instalación y al empleo).

### Garantía

Para que sea efectiva la garantía relativa al funcionamiento y a la seguridad, es necesario que se observen las indicaciones de estas instrucciones. En caso de no observancia de las indicaciones de advertencia pueden producirse lesiones corporales y daños materiales. El fabricante no se hace responsable de los daños que se produzcan como consecuencia de la no observancia de las indicaciones. La garantía no cubre pilas, fusibles ni bombillas. ¡Con objeto de evitar errores de montaje en la puerta y en el automatismo es estrictamente necesario proceder conforme a las indicaciones de las instrucciones de montaje! Sólo se debe poner en funcionamiento el producto después de haber leído las instrucciones de montaje y de manejo correspondientes.

Las instrucciones de montaje y de manejo se le tienen que entregar al usuario de la instalación de la puerta, el cual ha de guardarlas debidamente. Ellas contienen importantes indicaciones para el manejo, el control y el mantenimiento.

El producto se fabrica en conformidad con las directivas y normas aducidas en la declaración del fabricante y en la declaración de conformidad. El producto ha salido de la fábrica en un estado impecable en lo que respecta a la técnica de seguridad.

Es necesario que un perito inspeccione puertas, portones y ventanas accionadas mediante motor antes de la primera puesta en funcionamiento y siempre que ello sea preciso, pero como mínimo una vez al año (con certificación escrita).

### Utilización reglamentaria

El automatismo ha sido construido exclusivamente para la apertura y el cierre de puertas de garaje.

Sólo se permite el funcionamiento dentro de recintos secos.

Hay que tener en cuenta la fuerza máxima de tracción y de presión.

### Requerimientos a la puerta

La puerta tiene que:

- quedarse quieta en autoenclavamiento (mediante compensación elástica),
- marchar con facilidad.

**¡Además de las indicaciones contenidas en estas instrucciones, hay que observar también las prescripciones generales vigentes para la seguridad y para la prevención de accidentes! Rigen nuestras condiciones de venta y de suministro.**

### Indicaciones para el montaje del automatismo

- Asegúrese de que la puerta se encuentra mecánicamente en buen estado.
  - Asegúrese de que la puerta se detiene en todas las posiciones.
  - Asegúrese de que es posible mover la puerta con facilidad en dirección ABIERTO y CERRADO.
  - Asegúrese de que la puerta abre y cierra correctamente.
  - Retire de la puerta todos los elementos que no se necesiten (p.ej. cables, cadenas, escuadras etc.).
  - Poner fuera de servicio todos los dispositivos que no se requieran después del montaje del automatismo.
  - Antes de realizar trabajos de cableado, es estrictamente necesario cortar el suministro eléctrico del automatismo. Asegúrese de que la corriente se mantiene cortada mientras que se llevan a cabo los trabajos de cableado.
  - Observe las normativas locales de protección.
  - ¡Es estrictamente necesario tender por separado las líneas de red y de control! La tensión de control es de 24 V DC.
  - Monte el automatismo sólo con la puerta cerrada.
  - Monte todos los generadores de impulsos y dispositivos de control (p.ej. pulsador de código por radio) dentro del campo de visión de la puerta, pero a una distancia segura con respecto a las partes móviles de la misma. Hay que respetar una altura mínima de montaje de 1,5 metros.
  - Coloque en un lugar llamativo y de forma visible y permanente los letreros de advertencia contra aplastamiento.
  - Asegúrese de que después del montaje ninguna parte de la puerta sobresale hasta aceras públicas o calles.
- Indicaciones para la puesta en funcionamiento del automatismo Después de la puesta en funcionamiento de la instalación de la puerta hay que instruir en el manejo de la misma al propietario o a su representante.
- Asegúrese de que los niños no pueden jugar con el control de la puerta.
  - Antes del movimiento de la puerta, asegúrese de que no hay personas u objetos en la zona de peligro de la puerta.
  - Compruebe todos los dispositivos presentes de órdenes de emergencia.
  - No agarre jamás una puerta en marcha o partes en movimiento.
  - Preste atención a los lugares de la instalación de la puerta donde exista la posibilidad de que se produzcan aplastamientos o cortes.
- Hay que observar lo establecido por la norma EN 13241-1.

### Indicaciones para el mantenimiento del automatismo

Para garantizar un funcionamiento libre de errores hay que controlar regularmente los puntos siguientes, y dado el caso tomar las medidas oportunas. Siempre hay que cortar la tensión del automatismo antes de llevar a cabo trabajos en la instalación de la puerta.

- Una vez al mes hay que comprobar si el automatismo invierte la marcha de la puerta cuando ésta toca un obstáculo. Coloque para ello, en correspondencia con la dirección de marcha de la puerta, un obstáculo de 50 mm de alto/ancho en el trayecto de la puerta
- Compruebe el ajuste del automatismo de desconexión ABIERTO y CERRADO.
- Compruebe todas las partes móviles del sistema de la puerta y del automatismo.
- Compruebe si hay desgaste o daños en la instalación de la puerta.
- Compruebe a mano la suavidad de marcha de la puerta.

### Indicaciones para la limpieza del automatismo

Para la limpieza no se debe emplear en ningún caso: chorro de agua directo, equipo de limpieza a alta presión, ácidos o lejías.

### 3. Datos técnicos EN05, EN10

#### Datos eléctricos

- Tensión nominal
- Frecuencia nominal
- Consumo de corriente
- Consumo de energía funcionamiento
- Consumo de energía modo de espera (stand-by)
- Modo de funcionamiento (duración de conexión)
- Tensión de mando
- Tipo de protección grupo del motor
- Clase de protección

#### EN05

230 V  
50 Hz  
0,7 A  
0,2 KW  
< 3,9 W  
KB 2 min.  
24 V DC  
IP 20  
II

#### EN10

230 V  
50 Hz  
0,7 A  
0,26 KW  
< 3,9 W  
KB 2 min.  
24 V DC  
IP 20  
II

#### Datos mecánicos

- Fuerza máx. de tracción y de presión
- Velocidad de marcha
- Tiempo de apertura (específico de la puerta)

500 N  
140 mm/seg.  
aprox. 15 segs.

1000 N  
140 mm/seg.  
aprox. 15 segs.

#### Datos del entorno

- Dimensiones grupo del motor
- Peso
- Rango de temperatura

160x215x395 mm  
5,90 kg  
de -20 °C hasta +60°C

160x215x395 mm  
6,70 kg  
de -20 °C hasta +60°C

#### Volumen de suministro

- Bloque motor EN05 con control electrónico integrado
- Antena de módulo

#### Propiedades/Funciones de seguridad

- Técnica de punto de referencia
- Arranque suave / Parada suave
- Seguro contra empuje
- Automatismo de desconexión
- Protección contra bloqueo
- Protección contra baja tensión
- Limitación de tiempo de marcha
- Desconexión final electrónica
- Conexión para pulsador de presión, de código y de llave
- Conexión para aviso palpador final libre de potencial
- Señalización de errores

## 4. Sinopsis del producto

### 4.1 Volumen de suministro EN05, EN10

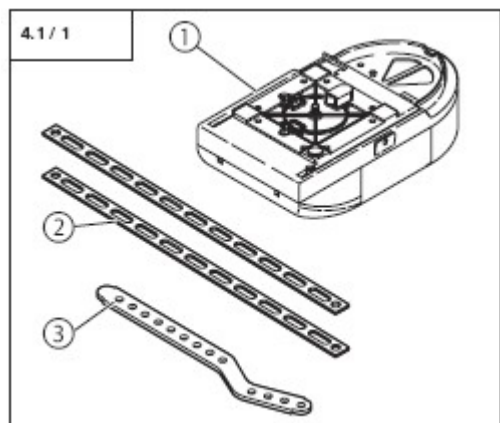

- 1- Bloque motor EN05, EN10
- 2- Chapa de colgadura
- 3- Arrastrador de la puerta

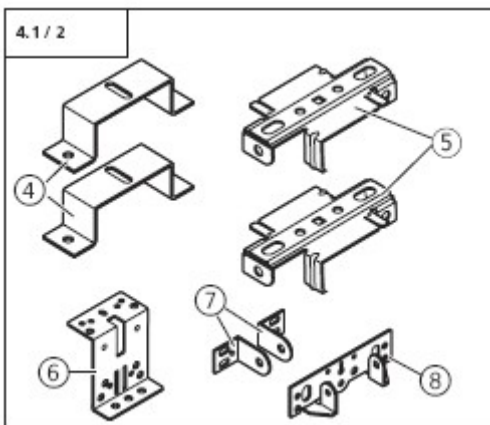

- 4- Fijación de carril (2x)
- 5- Pinza de colgadura (2x)
- 6- Elemento de unión de la puerta
- 7- Codo de arrastre de la puerta (2x)
- 8- Chapa de unión del dintel

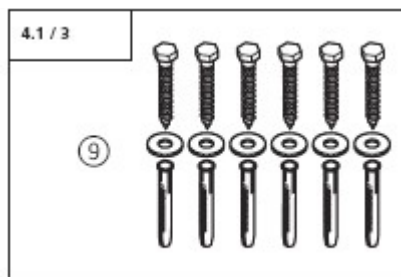

- 9- Material de fijación carril

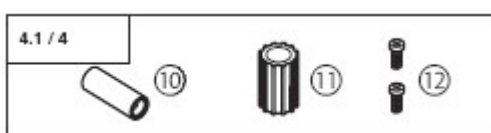

- 10- Manguito de seguridad
- 11- Manguito adaptador
- 12- Tornillos 4,0 x 10 (2x)



- 13- Tornillos 4,0 x 18 (2x)
- 14- Pasador 8 x 20

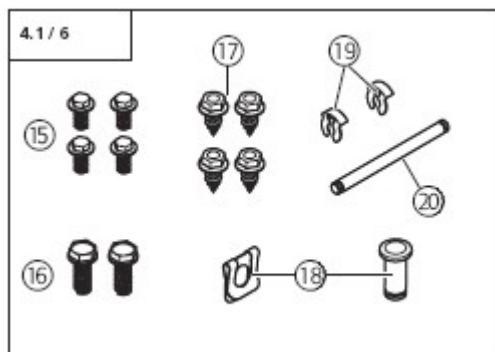

- 15- Tornillos 6 x 14 (4x)
- 16- Tornillos hexagonales M6 x 20 (2x)
- 17- Tornillos de chapa 6,3 x 16 (4x)
- 18- Pasador A8 con seguro SL
- 19- Clips de seguridad (2x)
- 20- Pasador de articulación ø 6

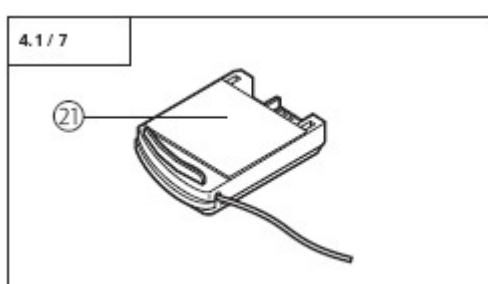

- 21- Antena de módulo 433MHz

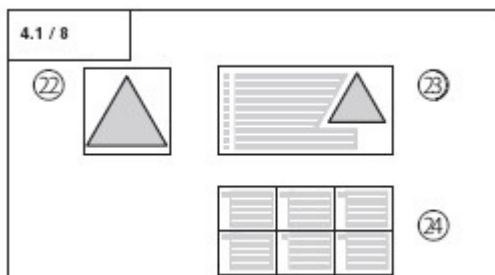

- 22 Letrero de advertencia desbloqueo
  - 23 Adhesivo de advertencia
  - 24 Adhesivo programación rápida
- Además del volumen de suministro estándar, para el montaje se requieren los accesorios siguientes:
- Carril de operación

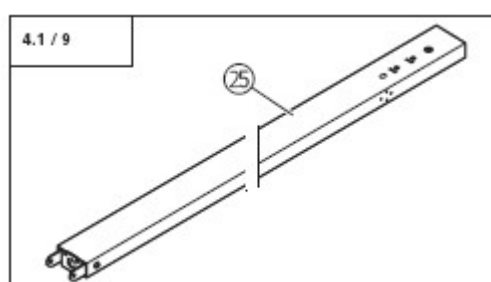

#### Carriles de operación

El bloque motor puede combinarse con diferentes carriles de operación.

- 25 Carril de operación

## 4.2 Variantes de puerta

El volumen estándar de suministro con carril de operación correspondiente es apropiado para las siguientes variantes de puerta.

### Puerta basculante que oscila hacia afuera

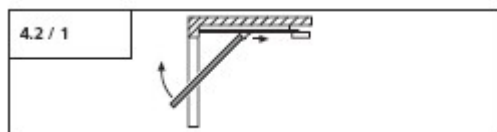

### Puerta seccional hasta una anchura de 3 m

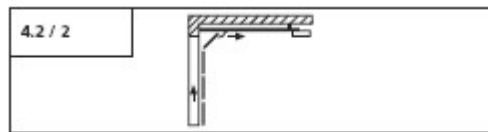

Para la siguientes variante de puerta se necesitan accesorios adicionales.

### Puerta basculante que no oscila hacia afuera

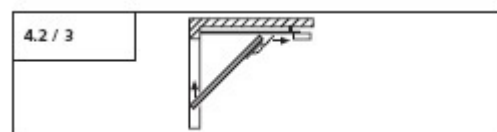

## TABLA CON SUGERENCIAS PARA ELEGIR EL MODELO DE AUTOMATIZACIÓN DE TRACCIÓN EN05 – EN10 PARA PUERTAS SECCIONALES RESIDENCIALES

**ATENCIÓN: EL ELEMENTO FUNDAMENTAL ES EL PERFECTO EQUILIBRADO DE LA PUERTA SECCIONAL.**

La utilización prevista es residencial, para puertas de garaje de viviendas unifamiliares o bifamiliares. En caso de puertas de acceso a un garaje de comunidad, con un uso intensivo, se recomienda el Art. EN10. H: Altura de la puerta L: Anchura de la puerta

Guía	H/L (mm)	2.000	2.500	3.000	3.500	4.000	4.500	5.000	5.500	6.000
<b>EN11</b>	2.250	EN05	EN05	EN05	EN05	EN05	EN10	EN10	EN10	EN10
<b>EN12</b>	2.500	EN05	EN05	EN05	EN05	EN10	EN10	EN10	EN10	EN10
<b>EN13</b>	3.250	EN05	EN05	EN05	EN10	EN10	EN10	EN10	EN10	EN10



### ¡Atención!

Para garantizar un montaje correcto, antes de empezar con el trabajo es estrictamente necesario realizar los controles siguientes.

## 5. Preparativos para el montaje

### Volumen de suministro

- Compruebe si está completo el volumen de suministro.
- Compruebe si están disponibles los accesorios requeridos para su situación particular de montaje.

### Garaje

- Compruebe si su garaje dispone de una conexión de corriente adecuada y de un dispositivo de separación de la red.

### Instalación de la puerta



### ¡Atención!

En caso de garajes sin segunda entrada: Para poder acceder al garaje en caso de una avería, la puerta del garaje tiene que estar equipada de un desbloqueo de emergencia.

Si se emplea un juego de desbloqueo:

- Compruebe regularmente que los cierres de la puerta funcionan correctamente. Los cierres de la puerta no se deben poner fuera de función bajo ninguna circunstancia.

Si no se emplea un juego de desbloqueo:

- Desmonte los cierres de la puerta o póngalos fuera de función.
- Compruebe si la puerta que se ha de accionar cumple las condiciones siguientes:
  - Tiene que ser posible mover fácilmente la puerta con la mano.
  - La puerta tiene que detenerse por sí misma en cualquier posición.



**Referencia:**

Al emplear y al montar accesorios hay que observar las instrucciones adjuntas correspondientes.

## 6. Montaje

### 6.1 Montaje del bloque motor y del carril de operación

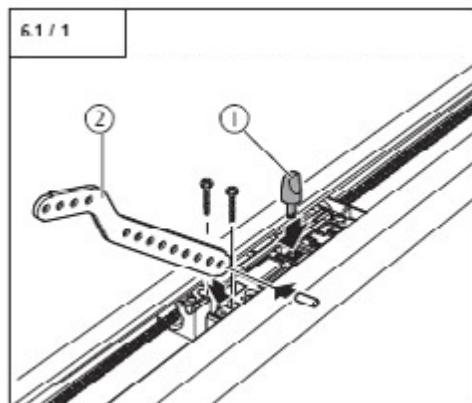

1. Poner la patilla de desbloqueo.
2. Montar el arrastrador de la puerta.

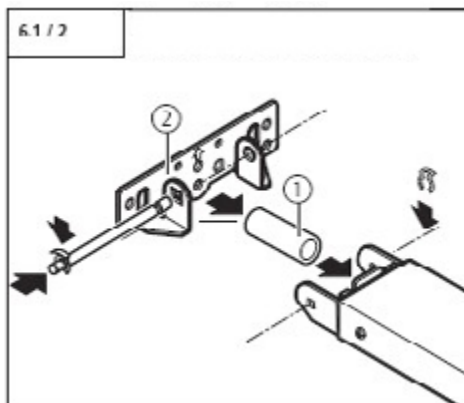

1. Poner el manguito de seguridad.
2. Montar la chapa de unión del dintel.

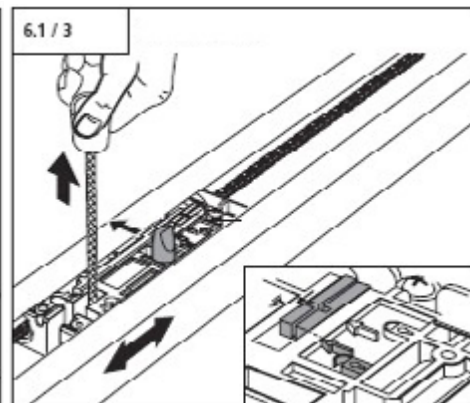

Desbloquear el carro.

#### 6.1.1 Montaje recto



**¡Atención!**

El carril de operación hay que montarlo con precaución sobre el bloque motor. ¡No debe emplearse violencia alguna, ya que en caso contrario pueden resultar dañados los dientes!

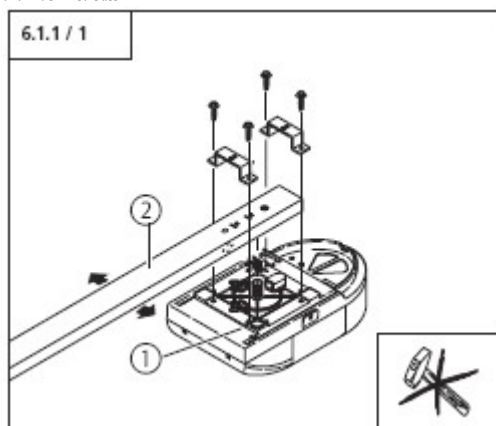

1. Meter el manguito adaptador en el eje del engranaje.
2. Montar el carril sobre la carcasa del motor.

#### 6.1.2 Montaje transversal



**Atención!**

- El carril de operación hay que montarlo con precaución sobre el bloque motor.
- No se debe emplearse violencia alguna, ya que en caso contrario pueden resultar dañados los dientes!
- Para garantizar el funcionamiento del automatismo hay que desplazar 90° el palpador de punto de referencia.

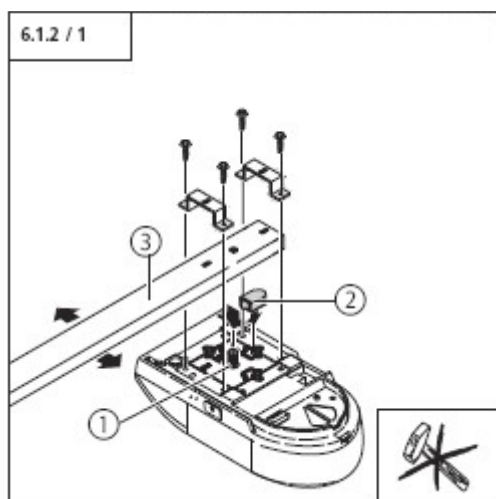

1. Colocar el manguito adaptador en el eje del engranaje
2. Desplazar el palpador del punto de referencia.
3. Mount el carril al grupo motor.

## 6.2 Montaje en puerta



### Precaución

Hasta su fijación, hay que asegurar el automatismo para que no se calga.

### Atención!

Para garantizar un funcionamiento impecable de la puerta:

- El carril de accionamiento hay que montar verticalmente sobre el codo de arrastre de la puerta.
- En el punto más alto de su trayectoria, el borde superior de la hoja de la puerta tiene que quedar 10 - 50 mm por debajo del borde inferior del carril de accionamiento en posición horizontal.

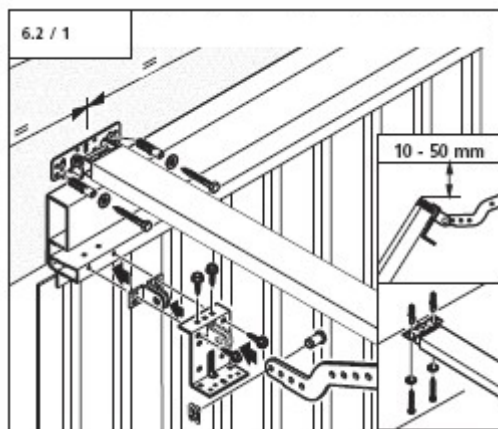

Montaje en puerta basculante

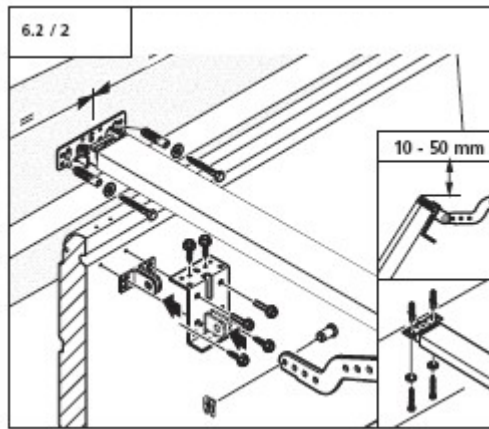

Montaje en puerta seccional.

## 6.3 Montaje al techo

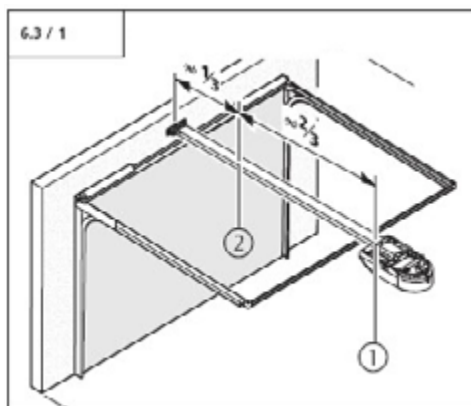

Determinar las posiciones de montaje 1 y 2

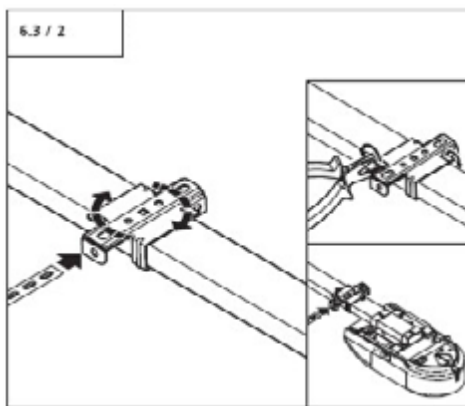

Montar las pinzas de colgadura a las posiciones de montaje.

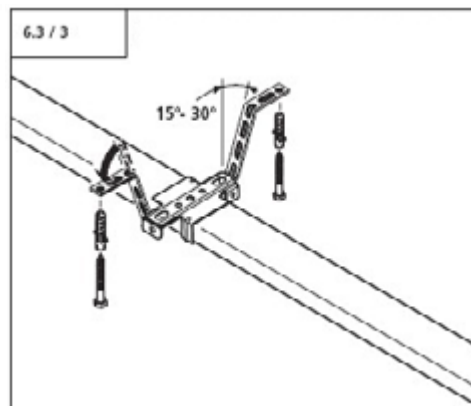

Doblar las chapas de colgadura y atornillares con el techo.

## 6.4 Desbloqueo



### Precaución!

Al accionar el desbloqueo pueden producirse movimientos incontrolados de la puerta:

- Si los resortes de la puerta son débiles o están rotos.
- Si la puerta no se encuentra en equilibrio

Al abrir la puerta a mano puede ser que el carro de guía colisione con el bloque motor.

Estando desbloqueada la puerta debe moverse sólo con una velocidad moderada!

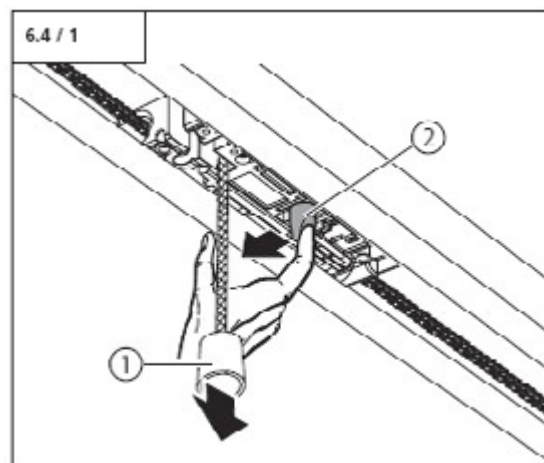

- Limite mediante medidas constructivas el recorrido de la puerta en dirección de apertura.
- Compruebe que la altura mínima del cable es de 1,8 m.
- Coloque el "Letrero de advertencia desbloqueo" en el cable.

1. Separar la puerta y el bloque motor.
2. Unir de nuevo la puerta y el bloque motor.



## 6.5 Conexiones del control



### ¡Precaución!

Peligro de descarga eléctrica: Antes de realizar trabajos de cableado hay que asegurarse de que los cables no conducen tensión. Durante la realización de los trabajos de cableado hay que asegurarse de que los cables se mantienen sin tensión (p.ej. excluir la posibilidad de una reconexión).



### ¡Atención!

#### Para evitar daños en el control:

- Hay que atenerse en todo momento las prescripciones locales de protección.
- Hay que tender por separado bajo cualquier circunstancia las líneas de red y de control.
- La tensión de control es de 24 V DC.
- La presencia de tensión ajena en las conexiones XP020, XB10 ó XB01 da lugar a la destrucción de la totalidad de la electrónica.
- En los bornes 1 y 2 (XB01) sólo se deben conectar contactos de trabajo libres de potencial.- ¡La clavija de cortocircuito no debe enchufarse en la hembrilla de sistema XP020!

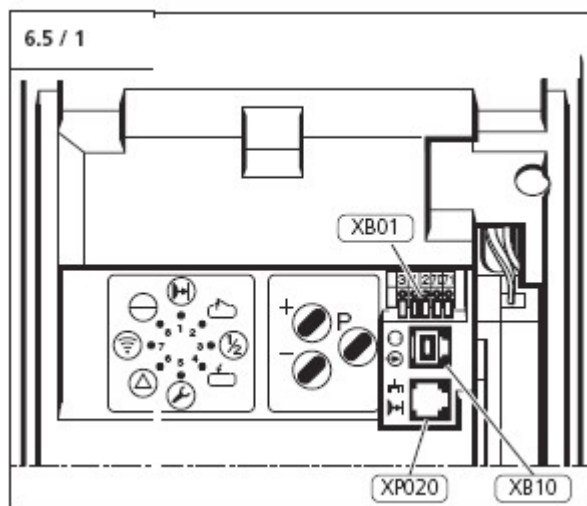

Possibilités de branchement.



#### Referencia:

Para el montaje de elementos de mando y dispositivos de seguridad y de señales externas hay que tomar en consideración las instrucciones correspondientes.



#### Indicación:

Antes de conectar un elemento de mando a las conexiones con hembrillas de sistema, hay que retirar primero la clavija de cortocircuito correspondiente.

**Conexión XB01: Es posible conectar un mando externo (selector o pulsador) o fotocélulas**

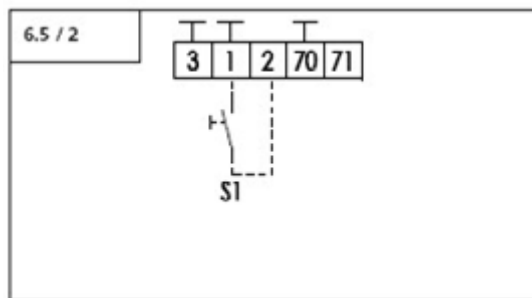

Conexión de la barrera fotoeléctrica ELVOX a XB01

Denominación	Tipo / Función	
XB01	Conexión de elementos de mando externos sin cableado de sistema y barrera fotoeléctrica de dos conductores	6.5 / 2
XB10	No en uso	-
XP020	Bornes para contacto NC. Art. EN0C (opcional) para añadir otro mando o fotocélula.	-

Denominación	Tipo / Función	
1	Conexión GND	
2	Entrada de impulsos programable	8.2 / Nivel 5
3	Conexión + 24 V DC (máx. 50 mA)	-
70	Sin función	-
71	Sin función	-
S1	Ejemplo de conexión: Pulsador de impulsos externo	8.2 / Nivel 5

Denominación	Tipo / Función	
1	COM, -	-
2	NC (CONTACTO NORMALMENTE CERRADO), NA (CONTACTO NORMALMENTE ABIERTO)	8.2 / Nivel 5
3	-	-

- plug **XP020**: es posible disponer de un contacto NC adicional (opcional), Art. EN0C, para utilizar un mando externo (selector o pulsador) y las fotocélulas (alimentación 24 V).

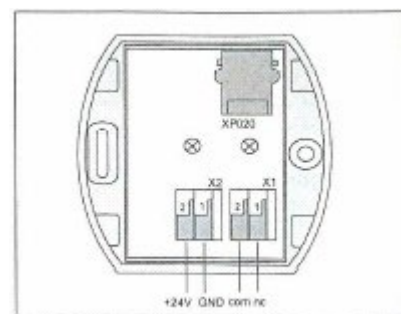

#### Referencia:

Tras la conexión de la barrera foto-eléctrica ELVOX, la entrada de impulsos programable tiene que ajustarse a la función C1 (el automatismo se detiene e invierte la marcha). La programación de la barrera fotoeléctrica se describe en el capítulo 8.2, menú 5.

## 6.6 Conexión de la luz de destellos ELVOX Art. ELA3 (alimentación 230V) al borne de la luz de cortesía



### ¡Atención!

Para evitar dañar la funda aislante del cable eléctrico, hay que colocar el cable de forma que no esté en contacto con la bombilla de la luz de cortesía.

- Retire la tapa de la luz de cortesía.
- Conecte la luz de destellos.
- Seleccione la función deseada (nivel 3, menú 1).
- Vuelva a colocar la tapa de la luz de cortesía.

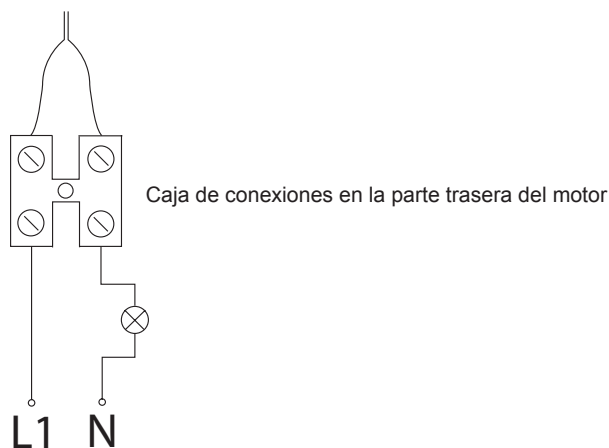

## 7. Puesta en funcionamiento

### 7.1 Conexión del automatismo

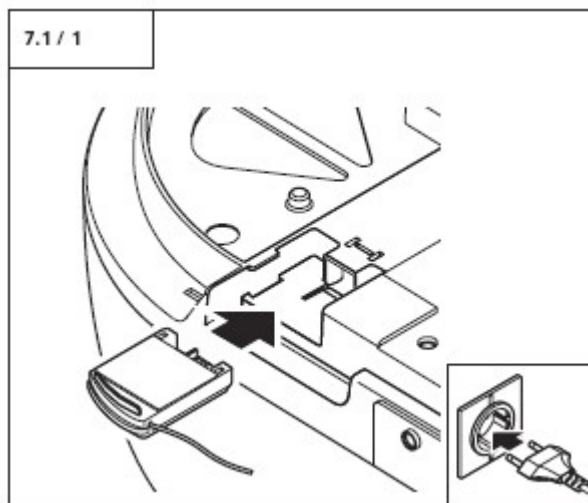

Conectar la antena modular y abastecer de corriente.

### 7.2 Sinopsis del control

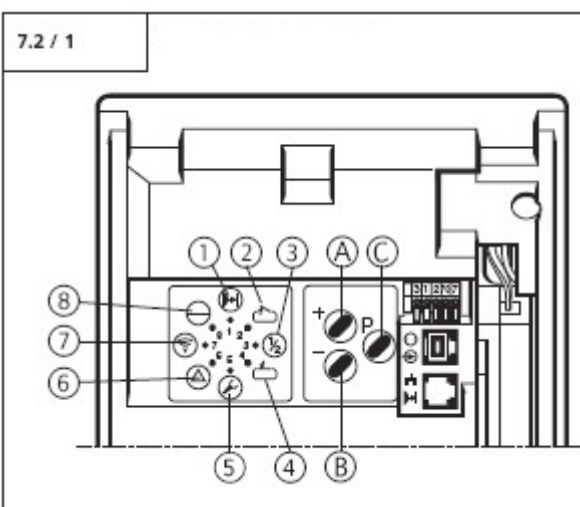

Possibilités de branchement.

#### Indicaciones LED

- 1- Barrera fotoeléctrica (Se ilumina sólo cuando se ha interrumpido la barrera fotoeléctrica)
- 2- Posición de puerta ABIERTO
- 3- Posición intermedia
- 4- Posición de puerta CERRADO
- 5- Control punto de referencia
- 6- Sin función
- 7- Emisión de impulsos (Control remoto, elementos de mando externos)
- 8- Funcionamiento







#### Elementos de mando

- A- Tecla (+) (p.ej. mover la puerta a la posición ABIERTO o elevar el valor de parámetros en la programación)  
 B- Tecla (-) (p.ej. mover la puerta a la posición CERRADO o reducir el valor de parámetros en la programación)  
 C- Tecla (P) (p.ej. cambio al modo de programación o guardar parámetros)

### 7.3 Sinopsis de las funciones de

#### Indicaciones LED en el modo de funcionamiento

	Barrera fotoeléctrica interrumpida
	La puerta marcha en dirección ABIERTO
	La puerta está en posición ABIERTO
	La puerta marcha en dirección CERRADO
	La puerta está en posición CERRADO
	Se conecta el punto de referencia
	Accionamiento prolongado de un elemento de mando externo
	Se acciona el control remoto
	Se dispone de tensión de servicio

Leyenda:	
LED apagado	
LED se ilumina	
LED parpadea lentamente	
LED parpadea rítmicamente	
LED parpadea rápidamente	
Entrega de fábrica	
No es posible	-

### 7.4 Programación rápida indicación

**Indicación:**  
 Para una puesta en funcionamiento adecuada del automatismo hay que llevar a cabo la programación rápida: Esto vale tanto para la primera puesta en funcionamiento como para después de un reset.

**Condiciones**  
 Antes de la programación rápida tienen que cumplirse las siguientes condiciones:  
 - La puerta se encuentra en la posición CERRADO.  
 - El carril de guía está acoplado.

**Indicación:**  
 Durante la programación de las posiciones de puerta ABIERTO y CERRADO hay que pasar por el punto de referencia.

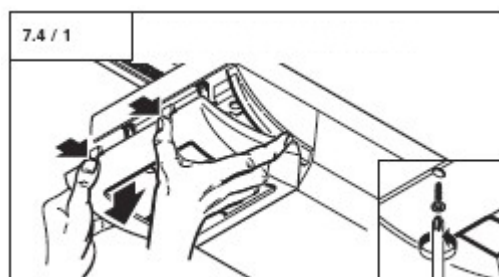













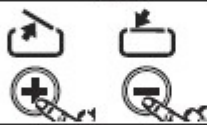
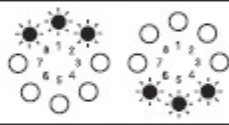

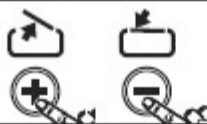
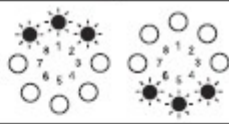
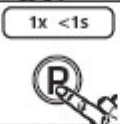

Quitar el parasol.

La programación se realiza con las teclas Más (+), Menos (-) y (P). Si en el modo de programación no se pulsa ninguna tecla dentro de un plazo de 120 segundos, el control retorna al estado de funcionamiento. Entonces se indica un aviso correspondiente.

**Referencia:**  
 La explicación de los avisos viene descrita en el punto 9.

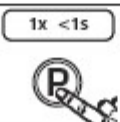
• Lleve a cabo una programación rápida de la mano del esquema que viene a continuación.

 <p>Modo de funcionamiento</p>	1.		Iniciar programación rápida / Programar la posición de puerta ABIERTO	
	2.		Mover la puerta a la posición ABIERTO	
	3.		Corrección de la posición de puerta ABIERTO con (+) y (-)	
	4.		Guardar la posición de puerta ABIERTO / Programar la posición de puerta CERRADO	
	5.		Mover la puerta a la posición CERRADO	
	6.		Corrección de la posición de puerta CERRADO con (+) y (-)	
	7.		Guardar la posición de puerta CERRADO / Programación del radiocontrol	
	8.		Accionar el emisor manual	
	9.		Soltar el emisor manual	
	10.		Guardar control remoto / Finalizar la programación rápida	

## PROGRAMACIÓN RÁPIDA EN05 - EN10

1. Con la puerta en posición de cierre total, alimente el actuador.  
 El led n. 8, que indica la presencia de alimentación, y el led n. 4, que indica la puerta cerrada, deben estar encendidos ○.
  
2. Para empezar la programación rápida, pulse la tecla P hasta que se enciendan los tres leds en la parte superior n. 8 - n. 1 - n. 2.
  
3. Suelte la tecla P y pulse la tecla "+". Mantenga pulsado la tecla "+" hasta la apertura total de la puerta. Durante la apertura de la puerta los 3 leds parpadean.  
 Realice las posibles correcciones utilizando las teclas "-" y "+".
  
4. Pulse la tecla P para memorizar el fin de carrera de apertura.  
 Se encienden los tres leds rojos en la parte inferior, n. 4 - n. 5 - n. 6.
  
5. Suelte la tecla P y pulse la tecla "-". Mantenga pulsado la tecla "-" hasta el cierre total de la puerta. Durante el cierre de la puerta los 3 leds parpadean. Realice las posibles correcciones utilizando las teclas "-" y "+".
  
6. Pulse la tecla P para memorizar el fin de carrera de cierre.  
 Se encienden los leds rojos n. 6 - n. 7 (parpadeante) - n. 8.
  
7. Pulse la tecla del mando a distancia.  
 El led n. 7 indica la memorización del código mediante un parpadeo rápido.
  
8. Pulse la tecla P para memorizar el código radio y manténgala pulsada durante 1 segundo.  
 Se encienden y se apagan todos los leds en sentido contrario a las agujas del reloj y el actuador sale de la programación para volver a las condiciones iniciales (leds n. 8 y n. 4 encendidos).
  
9. Para comprobar el correcto funcionamiento, pulsando la tecla del mando a distancia, accione la apertura y el cierre de la puerta.

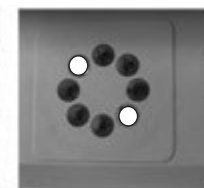
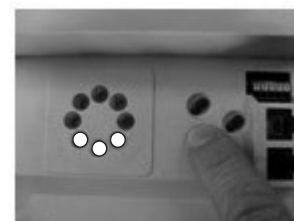
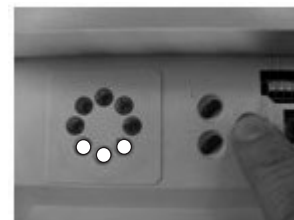
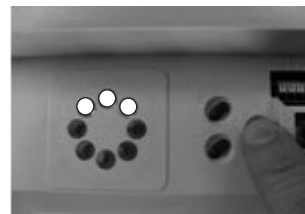
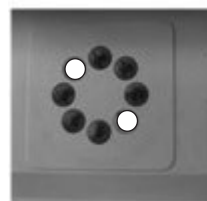

## 7.5 Comprobación del funcionamiento

### 7.5.1 Marcha de aprendizaje para la fuerza de operación



#### Controles:

Después de la programación rápida y después de realizar cambios en el menú de programación, hay que ejecutar las archas de aprendizaje y las comprobaciones siguientes.

El automatismo aprende la fuerza de operación máxima requerida durante las dos primeras marchas después del ajuste de las posiciones de puerta.

- Mueva el automatismo (con puerta acoplada) sin interrupción una vez de la posición de puerta CERRADO y la posición de puerta ABIERTO y a la inversa.

Durante esta marcha de aprendizaje, el automatismo determina la fuerza de tracción y de presión máximas, así como la reserva de fuerza, requerida para mover la puerta.

#### Comprobación:

1.		Después de pulsar la tecla (+): La puerta tiene que abrirse y moverse a la posición de puerta ABIERTO guardada.
2.		Después de pulsar la tecla (-): La puerta tiene que cerrarse y moverse a la posición de puerta CERRADO guardada.
3.		Después de pulsar la tecla del emisor manual: El automatismo tiene que mover la puerta en dirección ABIERTO o en dirección CERRADO.
4.		Después de pulsar la tecla del emisor manual mientras que el automatismo está en marcha: El automatismo tiene que detenerse..
5.		La siguiente vez que se pulse la tecla, el automatismo marchará en la dirección opuesta.

### 7.5.2 Control del automatismo de desconexión



#### ¡Precaución!

El automatismo de desconexión ABIERTO y CERRADO tiene que ajustarse correctamente para evitar daños personales y materiales.

#### Automatismo de desconexión ABIERTO

En caso de automatismos para puertas con aperturas en el ala (diámetro apertura > 50 mm):

- Recargue la puerta durante la marcha en el centro del borde inferior con una masa de 20 kg.

**La puerta tiene que detenerse de inmediato.**

#### Automatismo de desconexión CERRADO

- Coloque en el suelo un obstáculo de 50 mm de altura.
- Mueva la puerta contra el obstáculo.

**El automatismo tiene que detenerse e invertir cuando se tope con el obstáculo.**



#### Indicación:

Los ajustes de los parámetros no se pierden en caso de un corte del suministro de la tensión. La fuerzas de operación requeridas para ABIERTO y CERRADO se reponen a los ajustes de fábrica sólo después de una reinicialización o reset.

**8. Funciones ampliadas de operación**

**8.1 Esquema secuencial de la programación ampliada (Ejemplo para nivel 2, menú 2)**

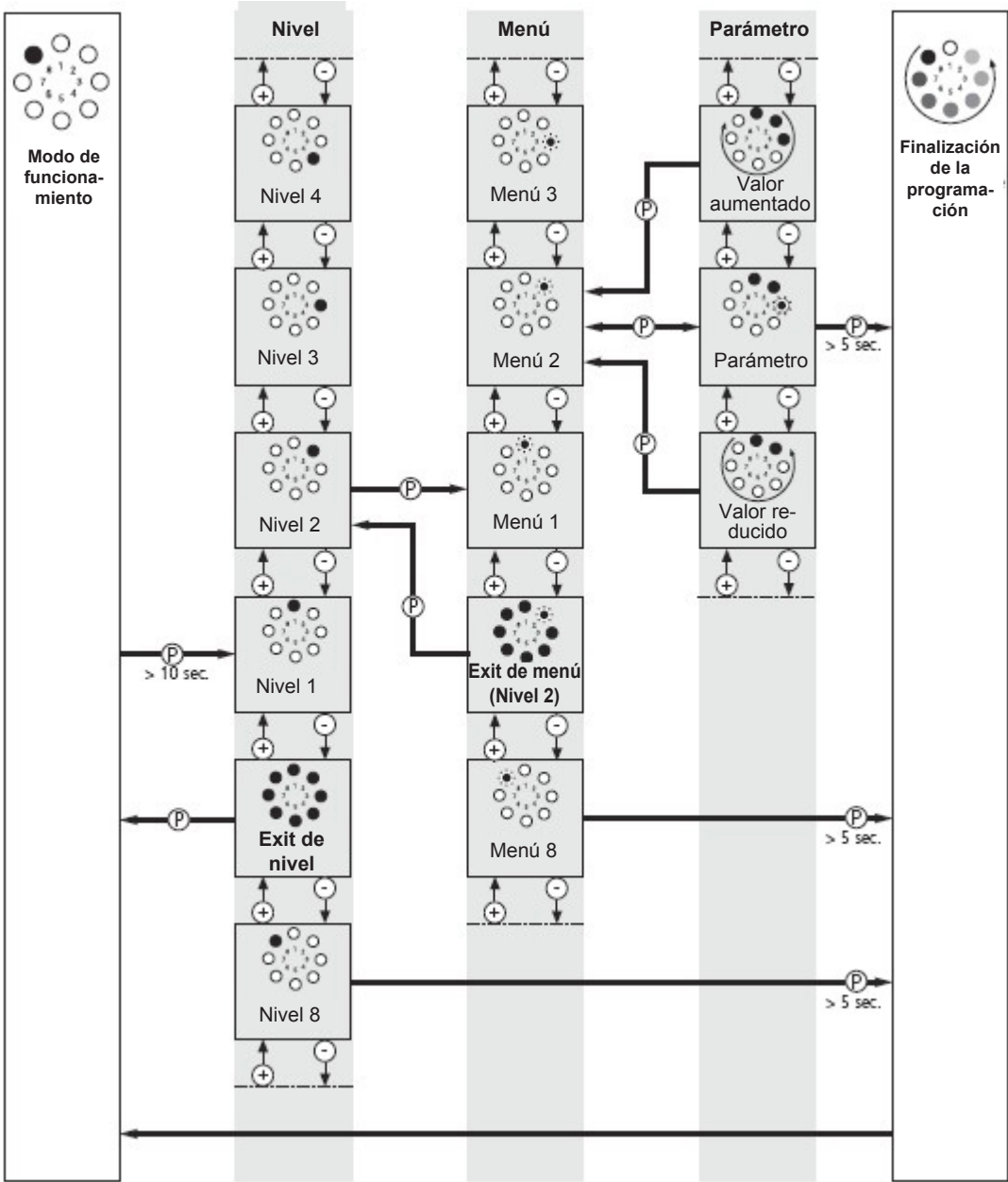

## 8.2 CONFIGURACIÓN RÁPIDA DE LAS FUNCIONES AVANZADAS DE PROGRAMACIÓN

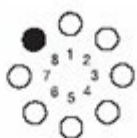

1. Pulse la tecla (P) durante > 10 segundos;
2. Espere que se apaguen todos los leds, en sentido contrario a las agujas del reloj, hasta llegar al primer led Nivel (1);

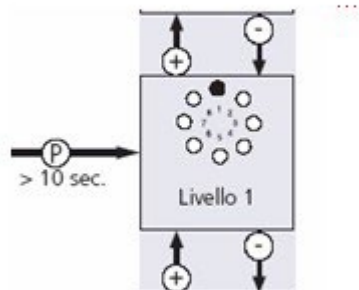

3. Suelte la tecla (P);
4. Seleccione con las teclas (+) y (-) el nivel deseado y pulse la tecla (P) para ver el menú del nivel (el led rojo parpadea);

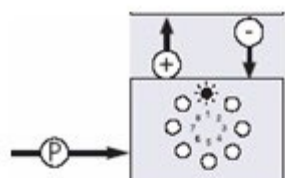

5. Con las teclas (+) y (-) seleccione el menú deseado;
6. Pulse la tecla (P) para entrar en el menú (el led rojo parpadea rápido);

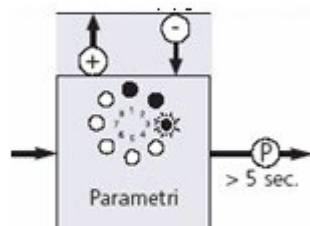

7. Pulsando las teclas (+) y (-) para modificar las funciones o los valores, consultando las tablas que aparecen en las instrucciones;
8. Un vez seleccionado el valor deseado, pulse la tecla (P) durante >5 segundos y suéltela al terminar el parpadeo de los leds en sentido contrario a las agujas del reloj.



Finalice la programación























### 8.3 Sinopsis de funciones de los niveles



#### ¡Precaución!

En las funciones ampliadas de operación es posible modificar importantes ajustes de fábrica. Hay que ajustar correctamente cada uno de los parámetros para evitar daños personales y materiales.

Nivel 1 - Funciones básicas																
	1	2	3	4	5	6	7	8	9	10	11	12	13	14	15	16
																
<b>Menú 3: Posición intermedia ABIERTO</b>																
	Ajustar con tecla (+ / ABIERTO) y (- / CERRADO) "Posición intermedia ABIERTO" – La función de cierre es posible con cierre automático															
<b>Menú 4: Posición intermedia CERRADO</b>																
	Ajustar con tecla (+ / ABIERTO) y (- / CERRADO)															
<b>Menú 5: Posición de marcha suave ABIERTO</b>																
	Ajustar con tecla (+ / ABIERTO) y (- / CERRADO)															
<b>Menú 6: Posición de marcha suave CERRADO</b>																
	Ajustar con tecla (+ / ABIERTO) y (- / CERRADO)															
<b>Menú 7: Salida de relé</b>																
	A7	B7	C7	D7	E7	F7	G7	H7	-	-	-	-	-	-	-	-
<b>Menú 8: Reset</b>																
	No	Si	-	-	-	-	-	-	-	-	-	-	-	-	-	-



#### ¡Atención!

Después de un reset, se restauran los ajustes de fábrica de todos los parámetros. Para garantizar un funcionamiento impecable del control:

- hay que reprogramar de nuevo todas las funciones deseadas,
- hay que realizar un aprendizaje del control remoto,
- el automatismo tiene que desplazarse una vez a la posición de la puerta ABIERTO y CERRADO.



#### Indicación:

- Sólo es posible emplear la posición intermedia programada en último lugar.
- Con el cierre automático activado (nivel 3 / menú) no se puede programar la salida de relé (nivel 1 / menú 7).











#### Referencia:

Después de realizar cambios en los menús 3 a 6 del nivel 1 hay que realizar una nueva marcha de aprendizaje para el automatismo de desconexión. La marcha de aprendizaje se describe en el punto 7.5.1.

#### Menú 7: Salida de relé

- A7- Automatismo en marcha / La lámpara de señales se ilumina
- B7- Automatismo en marcha / La lámpara de señales parpadea
- C7- 3 min. luz
- D7- Impulso transitorio
- E7- Error
- F7- Seguro contra empuje
- G7- Posición de puerta CERRADO
- H7- Posición de puerta ABIERTO

Nivel 2 – Ajustes del operador																
	1	2	3	4	5	6	7	8	9	10	11	12	13	14	15	16
Menú 1: Fuerza de operación requerida ABIERTO (sensibilidad en pasos*)																
	1	2	3	4	5	6	7	8	9	10	11	12	13	14	15	16
Menú 2: Fuerza de operación requerida ABIERTO (sensibilidad en pasos*)																
	1	2	3	4	5	6	7	8	9	10	11	12	13	14	15	16
Menú 3: Automatismo de desconexión ABIERTO (sensibilidad en pasos**)																
	OFF	2	3	4	5	6	7	8	9	10	11	12	13	14	15	16
Menú 4: Automatismo de desconexión CERRADO (sensibilidad en pasos**)																
	OFF	2	3	4	5	6	7	8	9	10	11	12	13	14	15	16
Menú 5: Velocidad ABIERTO (en pasos)																
	1	2	3	4	5	6	7	8	9	10	11	12	13	14	15	16
Menú 6: Velocidad CERRADO (en pasos)																
	1	2	3	4	5	6	7	8	9	10	11	12	13	14	15	16
Menú 7: Velocidad marcha suave ABIERTO (en pasos)																
	1	2	3	4	5	6	7	8	9	10	11	12	13	14	15	16
Menú 8: Velocidad marcha suave CERRADO (en pasos)																
	1	2	3	4	5	6	7	8	9	10	11	12	13	14	15	16

\* cuanto mayor el paso, tanto mayor es la fuerza de operación.

\*\* cuanto menor el paso, tanto más sensible es el automatismo de desconexión.







**¡Precaución!**

Para excluir la posibilidad de que se produzcan lesiones, el automatismo de desconexión (menú 3 y 4) puede programarse a DESCONECTADO sólo cuando haya conectada una barrera fotoeléctrica de paso o un seguro antiplastamiento.



**Referencia:**

Después de realizar cambios en los menús 5, 6, 7 y 8 del nivel 2 hay que realizar una nueva marcha de aprendizaje para el automatismo de desconexión. La marcha de aprendizaje se describe en el punto 7.5.1.

Nivel 3 - Cierre automático																
	1	2	3	4	5	6	7	8	9	10	11	12	13	14	15	16
Menú 1: Cierre automático																
	A1	B1	C1	D1	E1	F1	G1	H1	I1	-	-	-	-	-	-	-
Menú 3: Tiempo de apertura de la puerta (en segundos)																
	2	5	10	15	20	25	30	35	40	50	80	100	120	150	180	255
Menú 4: Tiempo de preaviso (en segundos)																
	1	2	5	10	15	20	25	30	35	40	45	50	55	60	65	70
Menú 5: Advertencia de puesta en marcha (en segundos)																
	0	1	2	3	4	5	6	7	-	-	-	-	-	-	-	-



**Indicación:**

- El cierre automático puede programarse sólo si hay conectada una barrera fotoeléctrica o un sistema antiplastamiento.
- Las funciones del menú 1 pueden modificarse a voluntad por medio de los valores temporales en los menús 3, 4 y 5.

**Menú 1: Cierre automático**

	Tiempo de apertura de la puerta	Tiempo de preaviso	Lámpara de señales	Otras funciones
A1	-	-	-	Cierre automático desactivado
B1	15	5	parpadea	-
C1	30	5	parpadea	-
D1	15	5	parpadea	Cierre después de atravesar la barrera fotoeléctrica
E1	30	5	parpadea	Cierre después de atravesar la barrera fotoeléctrica
F1	15	5	se ilumina	-
G1	30	5	se ilumina	-
H1	15	5	se ilumina	Cierre después de atravesar la barrera fotoeléctrica
I1	30	5	se ilumina	Cierre después de atravesar la barrera fotoeléctrica

**Nivel 4 – Programación remota**

















**Menú 1: Impulso**

El LED 7 parpadea lentamente -&gt; Pulsar tecla emisor manual -&gt; LED 7 parpadea rápidamente

**Menú 2: Posición intermedia**

El LED 7 parpadea lentamente -&gt; Pulsar tecla emisor manual -&gt; LED 7 parpadea rápidamente

**Nivel 5 – Función especial**

	1	2	3	4	5	6	7	8	9	10	11	12	13	14	15	16
																

**Menú 1: Entrada de impulsos programable – Borne 1/2**

	A1	B1	C1	D1	E1	-	-	-	-	-	-	-	-	-	-	-
--	----	----	----	----	----	---	---	---	---	---	---	---	---	---	---	---

**Menú 4: Tiempo de iluminación (en segundos)**

		5	10	15	20	25	30	35	40	50	80	100	120	150	180	255
--	--	---	----	----	----	----	----	----	----	----	----	-----	-----	-----	-----	-----

**Menú 1: Entrada de impulsos programable – Borne 1/2**

A1- Impulso (sólo contacto de trabajo)

















B1- Automatismo conectado / desconectado (sólo contacto de trabajo)

C1- El automatismo se detiene e invierte la marcha (sólo dirección CERRADO - sólo contacto de reposo / para la programación de la barrera fotoeléctrica ELVOX)

D1- Impulso ABIERTO (lazo de inducción - sólo contacto de trabajo)

E1- Parada (sólo contacto de reposo)

**Nivel 8 – Ajustes del sistema**

	1	2	3	4	5	6	7	8	9	10	11	12	13	14	15	16
																

**Menú 1: Barrera fotoeléctrica**

	A1	B1			-	-	-	-	-	-	-	-	-	-	-	-
--	----	----	--	--	---	---	---	---	---	---	---	---	---	---	---	---

**Menú 1: Barrera fotoeléctrica (sólo versión con comprobación)**







A1- Funcionamiento sin barrera fotoeléctrica

B1- Funcionamiento con barrera fotoeléctrica de sistema (XP020)







## 9. Avisos





### 9.1 Fallos sin indicación







Error	Causa	Eliminación
La indicación 8 no se ilumina.	- Falta tensión	- Comprobar si se dispone de tensión de red. - Comprobar la dificultad de marcha.
	- La termoprotección en el transformador de red se ha disparado.	- Dejar que se enfríe el transformador de red.
	- Unidad de mando defectuosa.	- Hacer comprobar el automatismo.
No hay reacción después de la emisión de impulsos.	- Bornes de conexión para pulsador "impulso" puenteados p.ej. por cortocircuito de línea o bornes planos.	- Dado el caso, separar a modo de prueba de la unidad de mando los pulsadores de llave o de presión interior que pudiera haber cableados (punto 6.5). Sacar el cable de la hembra XB10, enchufar la clavija de cortocircuito y buscar el error de cableado.
No hay reacción después de la emisión de impulsos por parte del emisor manual.	- Antena de módulo no enchufada.	- Conectar la antena modular con la unidad de control (punto 7.1).
	- La codificación del emisor manual no concuerda con la codificación del receptor.	- Activar de nuevo el emisor manual (punto 7.4).
	- La pila del emisor manual está gastada.	- Colocar una nueva pila..
	- Emisor manual o electrónica de control o antena de módulo defectuosos.	- Hacer comprobar todos los tres componentes.

Leyenda:	
LED apagado	
LED se ilumina	
LED parpadea lentamente	
LED parpadea rítmicamente	
LED parpadea rápidamente	
Entrega de fábrica	
No es posible	-

## 9.2 Fallos con indicación

Error	Causa	Solution
Aviso 7 	<ul style="list-style-type: none"> <li>- El modo de programación finaliza por si mismo después de 120 segundos sin pulsar ninguna tecla.</li> <li>- Programación de las posiciones de puerta ABIERTO y CERRADO sin pasar el punto de referencia.</li> </ul>	
Aviso 8 	<ul style="list-style-type: none"> <li>- Palpador punto de referencia defectuoso.</li> </ul>	<ul style="list-style-type: none"> <li>- Hacer comprobar el automatismo.</li> </ul>
Aviso 9 	<ul style="list-style-type: none"> <li>- No se dispone de impulsos de sensor de revoluciones, Automatismo bloqueado.</li> </ul>	<ul style="list-style-type: none"> <li>- Hacer comprobar el automatismo.</li> </ul>
Aviso10 	<ul style="list-style-type: none"> <li>- Marcha de la puerta demasiado dificultosa.</li> <li>- Puerta bloqueada.</li> </ul>	<ul style="list-style-type: none"> <li>- Hacer que la puerta marche con facilidad.</li> </ul>
	<ul style="list-style-type: none"> <li>- Limitación de fuerza máxima ajustada demasiado baja.</li> </ul>	<ul style="list-style-type: none"> <li>- Hacer que el distribuidor autorizado compruebe la limitación de fuerza máx. (punto 8.2 / nivel 2 / menú 1+2).</li> </ul>
Aviso 11 	<ul style="list-style-type: none"> <li>- Limitación de tiempo de marcha.</li> </ul>	<ul style="list-style-type: none"> <li>- Hacer comprobar el automatismo.</li> </ul>
Aviso 15 	<ul style="list-style-type: none"> <li>- Barrera fotoeléctrica externa defectuosa o interrumpida.</li> </ul>	<ul style="list-style-type: none"> <li>- Eliminar obstáculos o hacer comprobar la barrera fotoeléctrica.</li> </ul>
	<ul style="list-style-type: none"> <li>- Barrera fotoeléctrica programada, pero no conectada.</li> </ul>	<ul style="list-style-type: none"> <li>- Desactivar o conectar la barrera fotoeléctrica.</li> </ul>
	<ul style="list-style-type: none"> <li>- Sensor de corriente para el automatismo de desconexión defectuoso.</li> </ul>	<ul style="list-style-type: none"> <li>- Hacer comprobar el bloque motor.</li> </ul>

Error	Causa	Eliminación
Aviso 26 	<ul style="list-style-type: none"> <li>- Baja tensión, automatismo sobrecargado con ajuste fuerza máx. paso 16.</li> </ul>	<ul style="list-style-type: none"> <li>- Hacer comprobar la alimentación externa de tensión.</li> </ul>
Aviso 28 	<ul style="list-style-type: none"> <li>- Marcha de la puerta demasiado dificultosa o irregular.</li> <li>- Puerta bloqueada.</li> </ul>	<ul style="list-style-type: none"> <li>- Comprobar la marcha de la puerta y hacer que ésta marche con facilidad.</li> </ul>
	<ul style="list-style-type: none"> <li>- Automatismo de desconexión ajustado demasiado sensiblemente.</li> </ul>	<ul style="list-style-type: none"> <li>- Hacer que el distribuidor autorizado compruebe el automatismo de desconexión (punto 8.2 / nivel 2 / menú 3+4).</li> </ul>
Aviso 35 	<ul style="list-style-type: none"> <li>- Electrónica defectuosa.</li> </ul>	<ul style="list-style-type: none"> <li>- Hacer comprobar el automatismo.</li> </ul>
Aviso 36 	<ul style="list-style-type: none"> <li>- Clavija de cortocircuito retirada, pero no se ha conectado la tecla de detención.</li> <li>- Circuito de corriente de reposo interrumpido.</li> </ul>	<ul style="list-style-type: none"> <li>- Conectar la tecla de detención o enchufar la clavija de cortocircuito (punto 6.5).</li> </ul>

Leyenda:	
LED apagado	
LED se ilumina	
LED parpadea lentamente	
LED parpadea rítmicamente	
LED parpadea rápidamente	
Entrega de fábrica	
No es posible	-

## Table des matières

1.	Explicação dos símbolos.....	100
2.	Indicações gerais de segurança.....	101
3.	Dados técnicos EN05, EN10.....	102
4.	Vista de conjunto do produto.....	103
4.1	Volume de fornecimento EN05, EN10.....	103
4.2	Variantes de portão.....	104
5.	Preparações da montagem.....	104
6.	Montagem.....	105
6.1	Montagem do agregado do motor e carril do accionamento.....	105
6.2	Montagem do portão.....	106
6.3	Montagem no tecto.....	106
6.4	Destravamento.....	106
6.5	Conexões de comando.....	107
6.6	Ligação do intermitente ELVOX Art. ELA3 (alimentação 230V) ao borne da luz de cortesia.....	107
7.	Colocação em funcionamento.....	107
7.1	Conexão do sistema de accionamento.....	107
7.2	Vista de conjunto do comando.....	107
7.3	Vista de conjunto das funções de indicação.....	109
7.4	Programação rápida.....	109
7.5	Controlo de funcionamento.....	112
8.	Funções ampliadas do accionamento.....	113
8.1	Esquema operacional da programação ampliada (Exemplo para nível 2, menu 2).....	113
8.2	Definição rápida das funções avançadas de programação.....	114
8.3	Vista de conjunto das funções dos níveis.....	115
9.	Avisos.....	117
9.1	Avárias sem indicação de mensagens de avaria.....	118
9.2	Avárias com indicação de mensagem de avaria.....	118

## 1. Explicação dos símbolos



### Cuidado! Perigo de danos pessoais!

Aqui seguem indicações importantes de segurança, que devem ser indispensavelmente observadas para evitar danos pessoais!



### Atenção! Perigo de danos materiais!

Aqui seguem indicações importantes de segurança, que devem ser indispensavelmente observadas para evitar danos materiais!



### Observação / Dica



### Controlo



### Indicação

As seguintes informações são partes integrantes e essenciais do produto e devem ser entregadas ao utente. Lê-las atentamente porque dão importantes indicações concernentes a instalação, o uso e a manutenção. É necessário conservar as presentes informações para podê-las transmitir a eventuais futuros utentes da instalação. Uma instalação errónea ou uma utilização imprópria do produto pode ser fonte de grave perigo.

### IMPORTANTE - INFORMAÇÕES DE SEGURANÇA

- A instalação deve ser efetuada por pessoal profissionalmente competente e conforme as normas nacionais e europeias em vigor.
- Após abrir a embalagem verificar a integridade do aparelho, no caso de dúvida consultar um instalador ou pessoal especializado.
- Os elementos da embalagem (cartões, sacos de plástico, agrafos de fixação, polistireno etc.) devem ser colocados nos contentores do lixo e não devem ficar dispersos no ambiente e sobretudo não devem ficar ao alcance de crianças.
- A instalação, as ligações e as regulações devem ser efetuadas corretamente; os dados do cartão devem ser conformes a aqueles da rede eléctrica e a secção dos cabos de ligação deve ser idónea às cargas aplicadas, em caso de dúvida contactar pessoal qualificado.
- Não instalar o produto em ambientes com perigo de explosão ou estorvados por campos electro-magnéticos. A presença de gases ou fumos inflamáveis constitui um grave perigo para a segurança.
- Prever na rede de alimentação uma protecção para extratensões: um interruptor/seccionador e/ou diferencial idóneos ao produto e em conformidade com as normas em vigor.
- Indicar claramente (por meio dum cartão apropriado) no portão, porta, cortina ou barreira que são comandados a distância.
- A ELVOX S.p.A não pode ser considerada responsável por eventuais danos causados por a instalação incorreta dos dispositivos e/ou por componentes incompatíveis aos fins da integridade do produto, da segurança e do funcionamento.
- O aparelho destina-se só ao uso para o qual foi concebido pelo que qualquer outra aplicação é de considerar imprópria e portanto perigosa.
- Antes de efetuar qualquer operação de limpeza ou de manutenção, desligar o aparelho da rede, desligando a ficha ou apagando o interruptor da instalação.
- Para a reparação ou substituição das partes danificadas, deverão ser utilizados exclusivamente peças de cambio originais.
- O instalador deve fornecer todas as informações referidas ao funcionamento, à manutenção e à utilização das partes componentes simples e do sistema na sua totalidade.



### Norma 2002/96/CE (WEEE, RAEE)

O símbolo do cesto barrado referido no aparelho indica que o producto, no fim da sua vida útil, tendo que ser tratado separadamente dos refugos domésticos, deve ser entregue num centro de recolha diferenciada para aparelhagens eléctricas e electrónicas ou reconsignado ao revendedor no momento de aquisição dum novo aparelho equivalente.

O utente é responsável de entregar o aparelho a um ponto de recolha adequado no fim da sua vida. A recolha diferenciada de estes resíduos facilita a reciclagem do aparelho e dos seus componentes, permite o seu tratamento e a eliminação de forma compatível com o meio ambiente e prevem os efectos negativos na natureza e saúde das pessoas. Se se pretender mais informações sob os pontos de recolha, contacte o serviço local de recolha de refugos ou o negócio onde adquiriu o producto.

### Perigos referidos à substancias consideradas perigosas (WEEE).

Según a Directiva WEEE, substâncias que desde há tempo utilizam-se comunemente nos aparelhos eléctricos e electrónicos são consideradas substâncias perigosas para as pessoas e o ambiente. A dequada colecção diferenciada para o envio seguinte da aparelhagem deixada de usar para a reciclagem, ao tratamento e à eliminação ambientalmente compatível contribui a evitar possíveis efectos negativos no ambiente e na saúde e favorece o reciclo dos materiais dos quais o producto é composto.

## 2. Indicações gerais de segurança

### Por favor, ler indispensavelmente!

#### Público alvo

Este sistema de accionamento só deve montado, conectado e colocado em funcionamento por pessoal técnico treinado e qualificado!

Pessoal técnico qualificado e treinado, no sentido dessa descrição, são pessoas

- com conhecimento das prescrições gerais e específicas de prevenção de acidentes,
- com conhecimento das regulamentações electrotécnicas pertinentes,
- com formação no uso e manutenção de equipamentos de segurança adequados,
- com instrução e supervisão suficientes por técnicos em electricidade,
- com a capacidade de identificar os riscos que podem ser provocados pela electricidade,
- com conhecimento da aplicação da norma EN 12635 (Exigências à Instalação e Uso).

#### Garantia

Para uma garantia em relação ao funcionamento e à segurança é preciso que sejam respeitadas as indicações desse manual de instrução. Havendo desrespeito às indicações de advertência, podem ocorrer ferimentos corporais e danos materiais. O fabricante não responde por danos decorrentes do desrespeito às indicações.

Estão excluídas da garantia baterias, fusíveis e lâmpadas incandescentes.

Para evitar erros de montagem e danos no portão e no sistema de accionamento, é indispensável proceder conforme as instruções de montagem do manual de instalação! O produto só deve ser operado após tomada de conhecimento da instrução de montagem e operação pertinente. A instrução de montagem e operação deve ser entregue ao operador da instalação do portão e guardada.

Ela indicações importantes para a operação, controlo e manutenção.

O produto é fabricado conforme as directivas e normas contidas na declaração do fabricante e na declaração de conformidade.

O produto saiu de fábrica em perfeito estado técnico e de segurança.

No sector industrial, janelas, portas e portões accionados mecanicamente têm que ser testados por um especialista antes da primeira colocação em funcionamento e de acordo com a necessidade, mas, no mínimo, uma vez por ano (com comprovação por escrito).

#### Uso conforme a finalidade

O accionamento destina-se exclusivamente para abrir e fechar portões de garagem.

O funcionamento é permitido somente em ambientes secos. A força máxima de tracção e pressão precisa ser observada.

#### Exigências do portão

O portão tem que:

- ficar parado automaticamente (por meio de equilíbrio de mola),
- Movimentar-se facilmente.

Além das indicações deste manual devem ser respeitadas as prescrições gerais vigentes de segurança e contra acidentes!

Vigora nossas condições de venda e fornecimento.

#### Indicações para a montagem do sistema de accionamento

- Assegure-se de que o portão se encontra mecanicamente em bom estado.
- Assegure-se de que o portão fica parado em qualquer posição.
- Assegure-se de que o portão deixa se movimentar facilmente na direcção ABERTO e FECHADO.
- Assegure-se de que o portão abre e fecha correctamente.
- Remova todas as peças desnecessárias do portão (p. ex. cordas, correntes, ângulos etc.).
- Coloque fora de funcionamento todos os dispositivos que não forem necessários após a montagem do sistema de accionamento.
- Antes de realizar trabalhos de cablagem, desconecte indispensavelmente o sistema de accionamento da rede eléctrica.
- Assegure-se de que durante trabalhos de cablagem o abastecimento de corrente fique interrompido.
- Respeite as prescrições de protecção locais.
- Instale os cabos de rede e de comando indispensavelmente separados. A tensão de comando é de 24 V DC.
- Monte o sistema de accionamento somente em portão fechado.
- Monte todos os geradores de impulso e dispositivos de comando (p. ex. teclado a radiocódigo) ao alcance visual do portão, à distância segura de partes móveis do portão. Uma altura mínima de montagem de 1,5 metro deve se mantida.
- Fixe de forma permanente as placas de advertência contra entalção em lugares bem visíveis.
- Assegure-se de que, após a montagem, nenhuma parte do portão avance sobre vias públicas ou caminhos para pedestres.

#### Indicações para colocação em funcionamento do sistema de accionamento.

Os operadores do portão ou seus substitutos devem ser instruídos na operação, após a colocação em funcionamento da instalação.

- Assegure-se de que crianças não possam brincar com o comando do portão.
- Assegure-se antes de colocar o portão em movimento de que nenhuma pessoa ou objectos se encontrem na área de risco do portão.
- Controle todos os dispositivos de comando de emergência.
- Nunca pegue num portão em movimento ou em partes móveis.
- Preste atenção aos possíveis pontos de esmagamento e corte no sistema do portão. As disposições da NE 13241-1 devem ser observadas. Indicações para manutenção do sistema de accionamento. Para garantir um funcionamento livre de avaria, os pontos seguintes devem ser controlados regularmente e eventualmente reparados.
- Antes de executar trabalhos na instalação do portão, o accionamento sempre deve ser desconectado da corrente eléctrica.
- Controle mensalmente, se o sistema de accionamento inverte, quando o portão toca num obstáculo. Para tanto, coloque na correspondente direcção de marcha do portão um obstáculo de 50 mm de altura/largura no caminho do portão.
- Controle o ajuste do dispositivo automático de desconexão ABERTO e FECHADO.
- Controle todas as partes móveis do sistema de portão e accionamento.
- Controle a instalação do portão quanto a desgaste ou danificação.
- Controle à mão, se o portão se deixa movimentar facilmente.

#### Indicações para a limpeza do sistema de accionamento

Não devem ser usados de jeito nenhum na limpeza: jacto de água directo, limpador de alta pressão, ácidos ou solução alcalina.

### 3. Dados técnicos EN05, EN10

#### Dados técnicos

- Tensão nominal
- Frequência nominal
- Consumo de corrente
- Absorção de potência em operação
- Absorção de potência em stand-by
- Modo de operação (tempo de ligação)
- Tensão de comando
- Tipo de protecção do agregado do motor
- Classe de protecção

#### EN05

230 V  
50 Hz  
0,7 A  
0,2 KW  
< 3,9 W  
KB 2 min.  
24 V DC  
IP 20  
II

#### EN10

230 V  
50 Hz  
0,7 A  
0,26 KW  
< 3,9 W  
KB 2 min.  
24 V DC  
IP 20  
II

#### Dados mecânicos

- Força máxima de tracção e pressão
- Velocidade de movimento
- Tempo de abertura (específico para cada portão)

500 N  
140 mm/seg.  
cerca de 15 seg.

1000 N  
140 mm/seg.  
cerca de 15 seg.

#### Dados do ambiente

- Dimensões do agregado do motor
- Peso
- Faixa de temperatura

160x215x395 mm  
5,90 kg  
-20 até +60 °C

160x215x395 mm  
6,70 kg  
-20 até +60 °C

#### Volume de fornecimento

- Agregado de motor EN05, EN10 com comando electrónico integrado
- Antena modular

#### Características / Funções de segurança

- Tecnologia de ponto de referência
- Partida suave / parada suave
- Fusível de diferimento
- Dispositivo automático de desconexão
- Protecção anti-bloqueio
- Protecção de subtensão
- Limitação do tempo de movimento
- Desconexão final electrónica
- Conexão para teclas de pressão, tecla codificada e tecla chave
- Ligação de mensagem de sensor de fim de curso sem potencial
- Sinalização de defeitos



## 4. Vista de conjunto do produto

### 4.1 Volume de fornecimento EN05, EN10

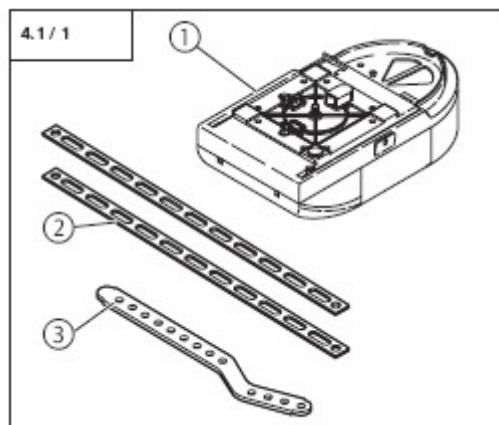

- 1- Agregado do motor EN05, EN10
- 2- Chapa de suspensão
- 3- Dispositivo de arrastamento do portão

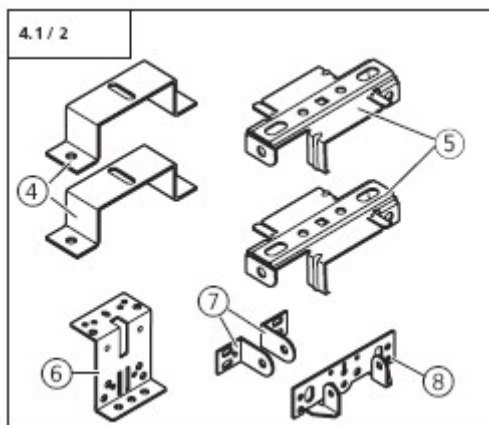

- 4- Fixação de barra (2x)
- 5- Grampo de suspensão (2x)
- 6- Elemento de ligação de portão
- 7- Ângulo de dispositivo de arrastamento do portão (2x)
- 8- Chapa de fixação no lintel

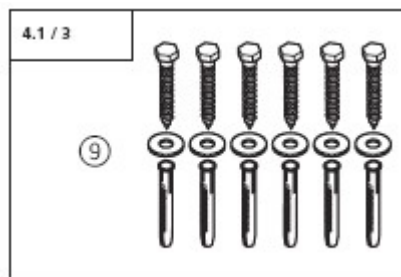

- 9- Material de fixação de barra

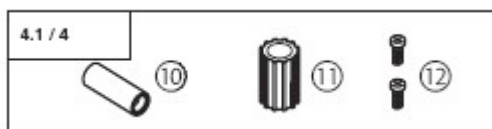

- 10- Casquilho de segurança
- 11- Casquilho de adaptação
- 12- Parafuso 4,0 x 10 (2x)

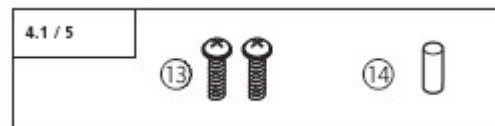

- 13- Parafuso 4,0 x 18 (2x)
- 14- Perno 8 x 20

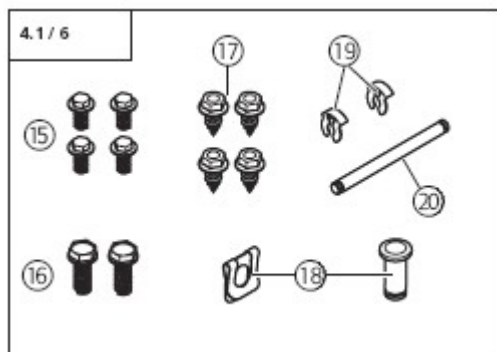

- 15- Vis 6 x 14 (4x)
- 16- Vis à tête hexagonale M6 x 20 (2x)
- 17- Vis à tête 6,3 x 16 (4x)
- 18- Goujon A8 avec sécurité SL
- 19- Clips de sécurité (2x)
- 20- Axe d'articulation ø 6

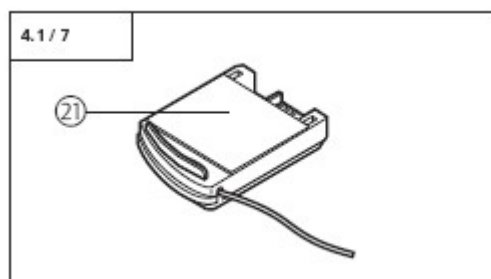

- 21- Antena modular 433 MHz

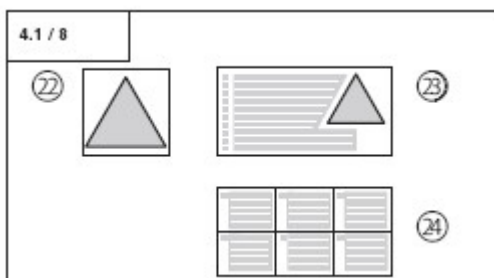

- 22- Placa de advertência de destravamento
  - 23- Auto-colante de advertência
  - 24- Auto-colante de programação rápida
- Além do fornecimento padrão, são necessários os seguintes acessórios para a montagem:
- Carril do accionamento

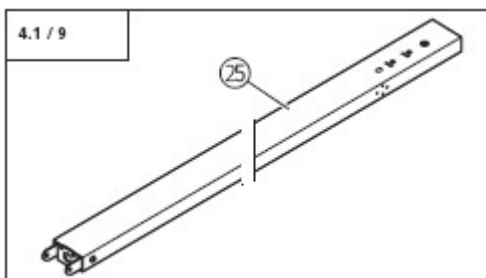

#### Carris do accionamento

O agregado do motor pode se combinar com diferentes carris do accionamento.

- 25- Carril do accionamento

## 4.2 Variantes de portão

O volume de fornecimento padrão com a respectiva barra de accionamento é adequado para as seguintes variantes de portão.

### Portão basculante oscilante (portão basculante)

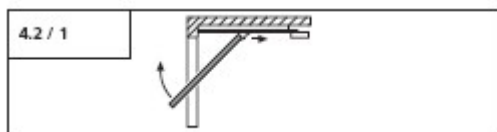

### Portão seccional até 3 m de largura

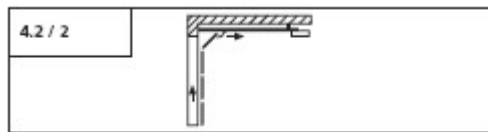

Para a seguinte variante de portão é necessário acessório especial.

### Portão basculante não-oscilante

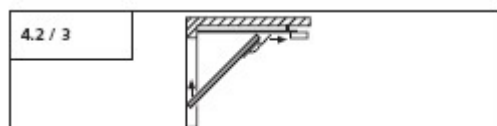

**TABELA COM SUGESTÕES PARA A ESCOLHA DO MODELO DE AUTOMATISMOS DE ARRASTAR EN05 – EN10 EM PORTAS SECCIONAIS RESIDENCIAIS**

**ATENÇÃO: O PERFEITO EQUILÍBRIO DA PORTA SECCIONAL É UM PRESSUPOSTO FUNDAMENTAL.**

A utilização prevista é a residencial, para portas de garagem de habitações mono ou bi-familiares. Caso as portas dêem acesso à garagem de um condomínio, de uso intensivo, recomendamos o art. EN10. H: Altura da porta L: Largura da porta

Guia	H/L (mm)	2.000	2.500	3.000	3.500	4.000	4.500	5.000	5.500	6.000
<b>EN11</b>	2.250	EN05	EN05	EN05	EN05	EN05	EN10	EN10	EN10	EN10
<b>EN12</b>	2.500	EN05	EN05	EN05	EN05	EN10	EN10	EN10	EN10	EN10
<b>EN13</b>	3.250	EN05	EN05	EN05	EN10	EN10	EN10	EN10	EN10	EN10



**Atenção!**

Para garantir uma montagem correcta, devem ser feitos indispensavelmente os controlos seguintes antes do início dos trabalhos.

## 5. Preparações da montagem

### Volume de fornecimento

- Confira se o volume de fornecimento está completo.
- Confira se as peças acessórias necessárias à sua situação de montagem estão disponíveis.

### Garagem

- Confira se sua garagem tem uma conexão eléctrica adequada e um interruptor de rede. Instalação de portão



**Atenção!**

Em garagens sem segunda entrada: para poder entrar na garagem em caso de avaria, o portão de garagem precisa ser equipado com um dispositivo de destravamento de emergência.

Se for usado um jogo de destravamento:

- Controle o funcionamento correcto das fechaduras do portão. As fechaduras do portão de jeito nenhum devem ser colocadas fora de funcionamento. Se não for usado um jogo de destravamento:
- Desmonte as fechaduras do portão ou coloque-as fora de funcionamento.

Confira se o portão a ser accionado preenche os seguintes requisitos:

- O portão tem que se deixar movimentar facilmente - à mão.
- O portão deve ficar parado por si mesmo em - qualquer posição.



**Indicação:**

Ao utilizar e montar acessórios, é necessário observar as respectivas instruções anexas.

## 6. Montagem

### 6.1 Montagem do agregado do motor e carril do accionamento

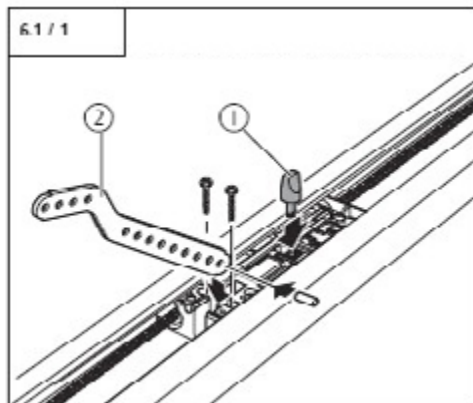

1. Encaixar pino de destravamento.
2. Montar dispositivo de arrastamento do portão.

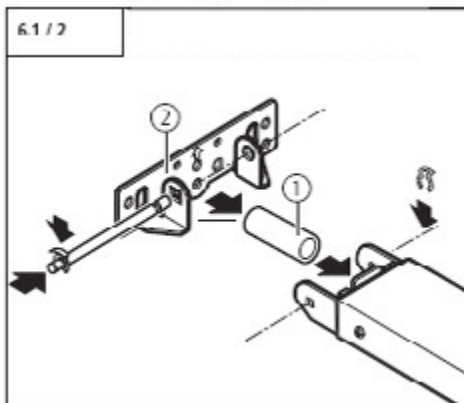

1. Introduzir bucha de segurança.
2. Montar chapa de ligação do dintel.

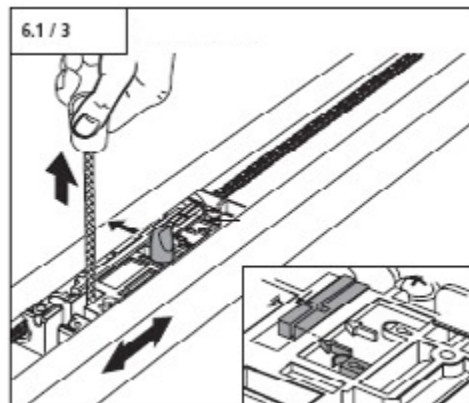

Destruar o cursor.

#### 6.1.1 Montagem recta



**Atenção!**

O carril do accionamento deve ser montado cautelosamente sobre o agregado do motor. Não deve ser aplicada força, caso contrário pode ser danificada a engrenagem!

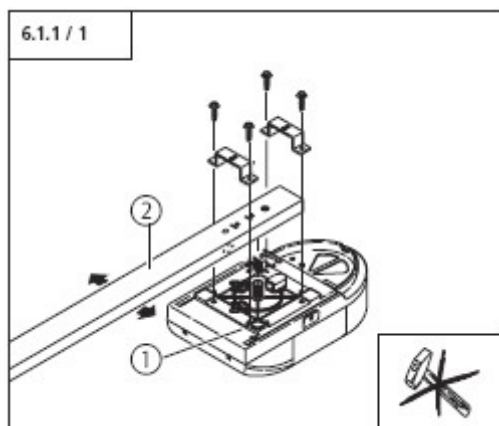

1. Encaixar a bucha de adaptação sobre o eixo do motor.
2. Montar carril sobre carcaça do motor.

#### 6.1.2 Montagem transversal



**Atenção !**

- O carril do accionamento deve ser montado cautelosamente sobre o agregado do motor. Não deve ser aplicada força, caso contrário pode ser danificada a engranagem!
- Para garantir o funcionamento do sistema de accionamento, o sensor do ponto de referência tem de ser deslocado a 90°

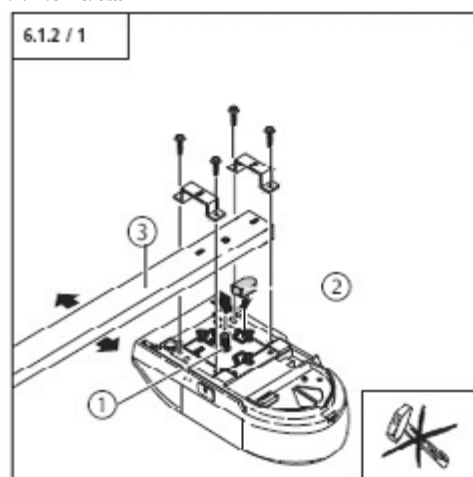

1. Inserir casquilho de adaptação no eixo de transmissão.
2. Deslocar ponto de referência.
3. Montar barra na carcaça do motor.

## 6.2 Montagem do portão



### Cuidado!

O sistema de accionamento tem que ser preso contra queda até sua fixação.

### Atenção!

Para garantir uma marcha perfeita do portão é preciso.

- montar o carril do accionamento verticalmente sobre o ângulo de arrastamento do portão.
- que o bordo superior da ensabladura do portão no ponto mais alto da trajetória de abertura fique 10 a 50 mm abaixo da borda inferior horizontal do carril de accionamento.

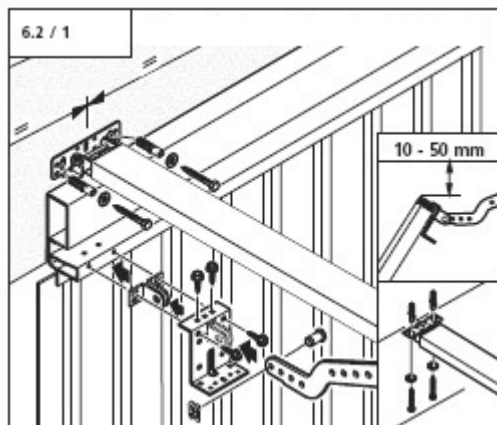

Montagem no portão basculante

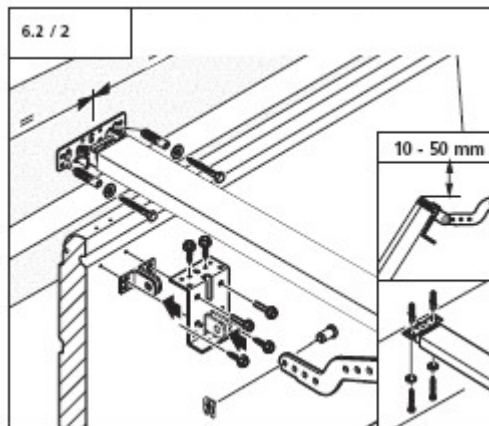

Montagem no portão seccional

## 6.3 Montagem no tecto

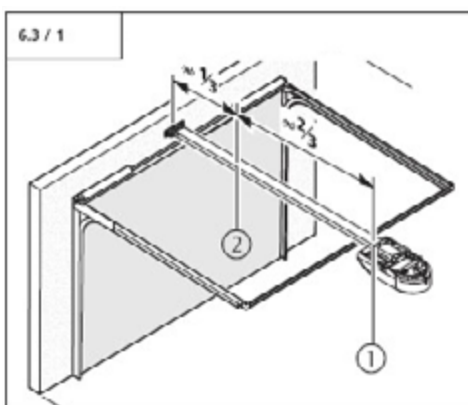

Definir posições de montagem 1 e 2.

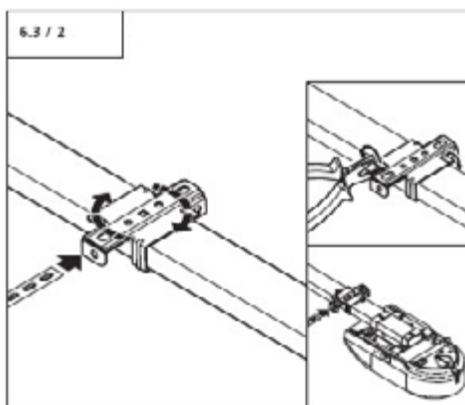

Montar grampos de suspensão nas posições de montagem

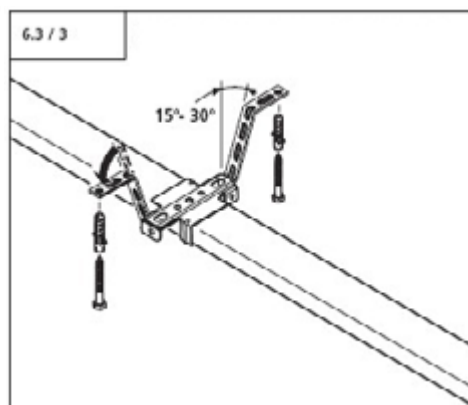

Dobrar chapas de suspensão e montá-las no tecto

## 6.4 Destravamento



### Cuidado!

Ao accionar o destravamento podem ocorrer movimentos descontrolados do portão:

- Se as molas do portão estiverem fracas ou quebradas
- Se o portão não se encontrar em equilíbrio

Ao abrir o portão à mão, o cursor de guia pode colidir com o agregado do motor

Em estado destravado, o portão só pode ser movimentado em velocidade moderada!

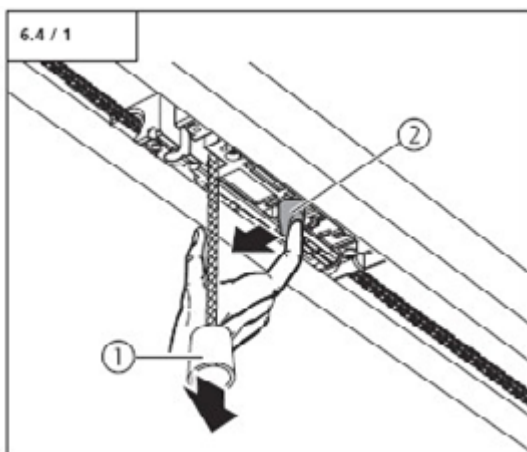

- Limite através de medidas de construção o caminho de marcha do portão na direcção Aberto.
- Controle a altura mínima de 1,8 do cabo de tracção.
- Fixe a "placa de advertência destravamento" no cabo de tracção.

1. Desconectar o portão do agregado do motor
2. Conectar novamente o portão com o agregado do motor.

## 6.5 Conexões de comando



### Cuidado!

Perigo de choque eléctrico:

Antes de realizar trabalhos de cablagem, é preciso assegurar-se de que as linhas estão livres de tensão (p. ex. para impedir religação).



### Atenção!

Para evitar danos no comando:

- As disposições de protecção locais deverão ser sempre respeitadas.
- É absolutamente necessário instalar as linhas de rede e comando em separado.
- A tensão de comando é de 24 V CC.
- A tensão estranha nas ligações XP020, XB10 ou XB01 provoca a destruição de toda a electrónica.
- Nos terminais 1 e 2 (XB01) só podem ser ligados contactos de trabalho sem potencial.
- A ficha de curto-circuito não pode ser inserida na tomada do sistema XP020!

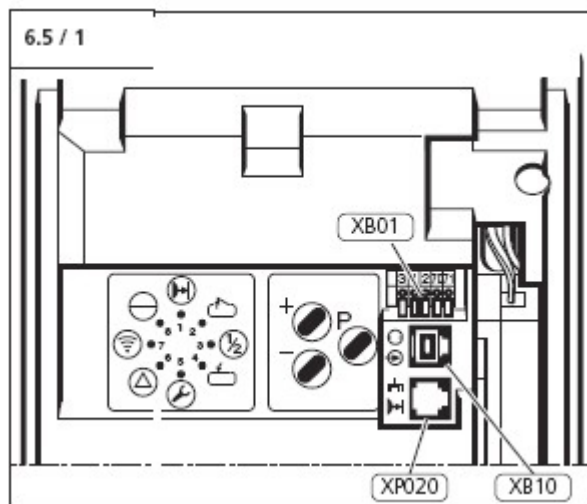

Possibilidades de conexão.

Designação	Tipo / Função	
XB01	Ligação de elementos de comando externos sem cablagem de sistema e barreira de luz de dois fios.	6.5 / 2
XB10	Não em uso	-
XP020	Borne para contacto N.C. Art. ENOC (opcional) para acrescentar um segundo comando ou fotocélula.	-



### Indicação:

Para a montagem de elementos de comando externos, dispositivos de segurança e sinalização, é necessário observar as respectivas instruções.



### Observação:

Antes da ligação de um elemento de comando nas ligações com as tomadas do sistema, a respectiva ficha de curto-circuito tem de ser removida.

### Ligação XB01

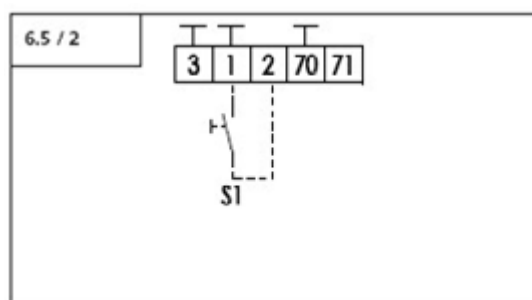

Ligação da barreira de luz ELVOX a XB01: Pode-se ligar um comando externo (selector ou botão) ou fotocélulas

Designação	Tipo / Função	
1	COM, -	-
2	NC (CONTACTO DE RUPTURA) NA (CONTACTO DE APERTURA)	8.2 / Nivel 5
3	-	-



### Indicação:

Depois da ligação da barreira de luz ELVOX, a entrada de impulsos programável tem de ser ajustada para a função C1 (o sistema de accionamento pára e faz inversão). A programação da barreira de luz está descrita no capítulo 8.2 Menu 5.

Designação	Tipo / Função	
1	Ligação TERRA	
2	Entrada de impulsos programável	8.2 / Nivel 5
3	Ligação + 24 V CC (máx. 50 mA)	-
70	Sem função	-
71	Sem função	-
S1	Exemplo de ligação: Botão de impulsos externo	8.2 / Nivel 5

- plug **XP020**: pode ter-se um contacto NC adicional (opcional), art. ENOC, para obter a utilização de um comando externo (selector ou botão) e das fotocélulas (alimentação de 24V).

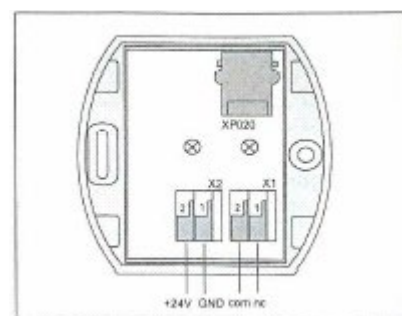

## 6.6 Ligação do intermitente ELVOX Art. ELA3 (alimentação 230V) ao borne da luz de cortesia

**Atenção!**  
Para evitar danificar a bainha isolante do cabo eléctrico, deverá sempre instalar o cabo de modo a que ele não fique em contacto com a lâmpada da luz de cortesia.

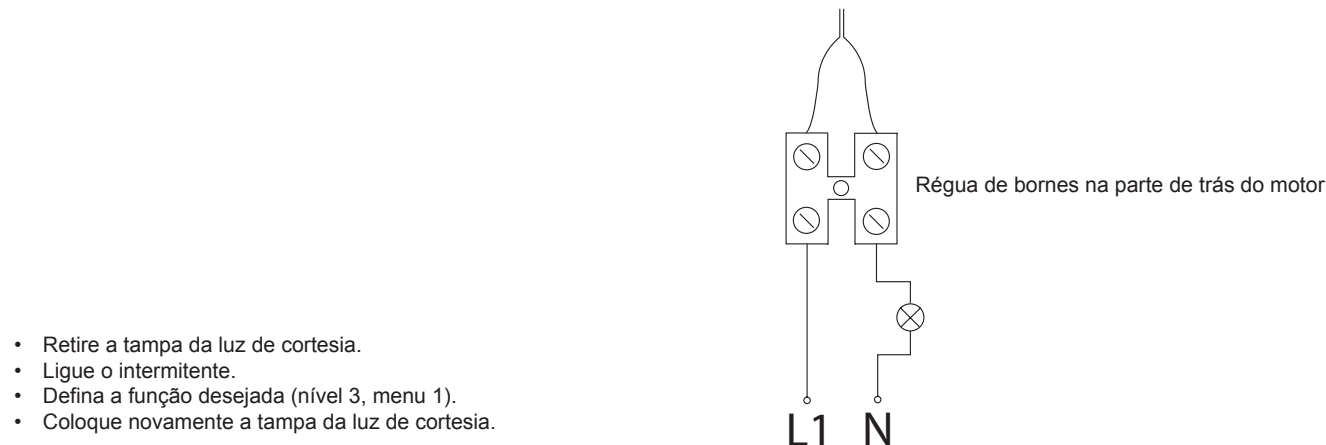

- Retire a tampa da luz de cortesia.
- Ligue o intermitente.
- Defina a função desejada (nível 3, menu 1).
- Coloque novamente a tampa da luz de cortesia.

## 7. Colocação em funcionamento

### 7.1 Conexão do sistema de accionamento

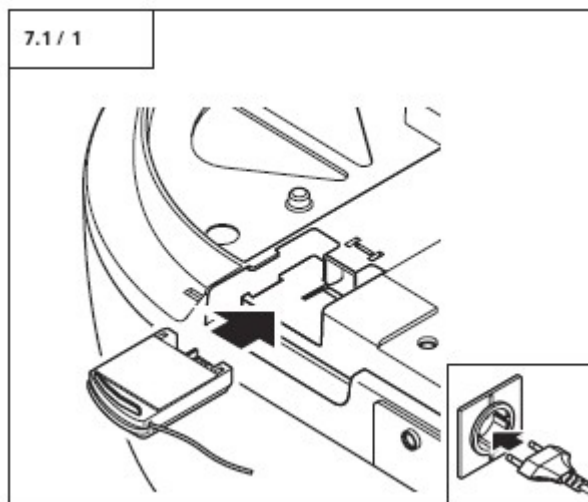

Encaixar antena modular e estabelecer a ligação de corrente.

### 7.2 Vista de conjunto do comando

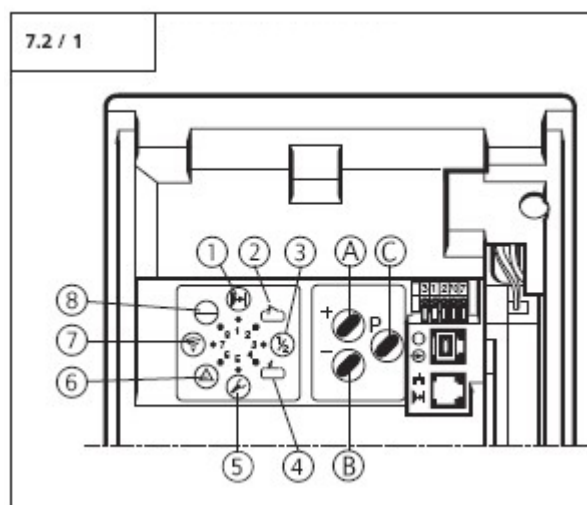

#### Indicador LED (diodos luminosos)

- 1- Barreira de luz (só acende se a barreira de luz estiver interrompida)
- 2- Posição de portão ABERTO
- 3- Posição intermédia
- 4- Posição de portão FECHADO
- 5- Controlo de ponto de referência
- 6- Sem função
- 7- Geração de impulso (Telecomando, elementos de comando externos)
- 8- Funcionamento









Vista de conjunto do comando.







#### Elementos de operação

- A- Tecla (+) (p. ex., levar o portão para a posição ABERTO ou aumentar parâmetros na programação)  
 B- Tecla (-) (p. ex., levar portão para a posição FECHADO ou diminuir parâmetros na programação)  
 C- Tecla (P) (p. ex., mudança no modo de programação ou memorizar parâmetros)

### 7.3 Vista de conjunto das funções de indicação

#### Indicações LED no modo de operação

	Barreira de luz interrompida
	Portão movimenta-se em direcção ABERTO
	Portão está na posição ABERTO
	Portão movimenta-se na direcção FECHADO
	Portão está na posição FECHADO
	Ponto de referência é comutado
	Accionamento permanente de um elemento de operação externo
	Controlo remoto é activado
	Tensão de operação ligada

Legenda:	
LED (diodo luminoso) apagado	
LED brilha	
LED pisca devagar	
LED pisca ritmicamente	
LED pisca rápido	
Fornecimento de fábrica	
Não é possível	

### 7.4 Programação rápida



#### Observação:

Para colocar o sistema de accionamento correctamente em funcionamento é preciso realizar a programação rápida. Isto vale para a primeira colocação em funcionamento e após um reset.

#### Condições

Antes da programação rápida devem ser preenchidas as seguintes condições:

- O portão encontra-se na posição FECHADO.
- O cursor de guia está engatado.



#### Observação:

Durante a programação das posições do portão ABERTO e FECHADO é preciso passar pelo ponto de referência.

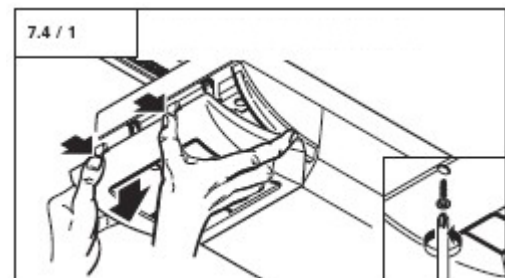

Remoção da antepara.

A programação é feita com as teclas mais (+), menos (-) e (P).





















Se no modo de programação, durante 120 segundos, não for apertada nenhuma tecla, o comando pula de volta para o estado de operação. É exibido um correspondente aviso.



#### Indicação:

A explicação dos avisos está descrita no ponto 9.

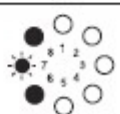
- Faça a programação rápida com base no seguinte esquema de procedimento.

 <p>Modo de operação</p>	1.	 <p>1x &gt;2s &lt;10s</p>	Iniciar a programação rápida / Programar posição portão ABERTO	
	2.		Movimentar o portão para a posição ABERTO	
	3.		Correcção da posição portão ABERTO com (+) e (-)	
	4.	 <p>1x &lt;1s</p>	Memorizar posição de portão ABERTO / Programar posição de portão FECHADO	
	5.		Movimentar o portão para a posição FECHADO	
	6.		Correcção da posição portão FECHADO com (+) e (-)	
	7.	 <p>1x &lt;1s</p>	Memorizar posição de portão FECHADO / Programar telecomando	
	8.		Accionar emissor manual	
	9.		Soltar emissor manual	
	10.	 <p>1x &lt;1s</p>	Memorizar telecomando / Concluir programação rápida	



## PROGRAMAÇÃO RÁPIDA EN05 - EN10

1. Com a porta na posição de fecho total, alimente o actuador.  
 O Led n.º 8, que indica a presença de alimentação, e o led n.º 4, que indica que a porta está fechada, devem estar acesos ○.
  
2. Para iniciar a programação rápida, prima a tecla P até que se acendam os três leds na parte superior n.º 8 - n.º 1 - n.º 2.
  
3. Solte a tecla P e prima "+". Mantenha o "+" premido até à abertura total da porta. Durante a abertura da porta os 3 leds piscam. Faça eventuais correcções utilizando a tecla "-" e "+".
  
4. Prima a tecla P para memorizar o fim de curso da Abertura.  
 Os três leds vermelhos acendem-se na parte inferior, n.º 4 – n.º 5 – n.º 6.
  
5. Solte a tecla P e prima a tecla "-". Mantenha o "-" premido até ao fecho total da porta. Durante o fecho da porta os 3 leds piscam. Faça eventuais correcções utilizando a tecla "+" e "-".
  
6. Prima a tecla P para memorizar o fim de curso do Fecho.  
 Os leds vermelhos n.º 6 – n.º 7 (intermitente) – n.º 8 acendem-se.
  
7. Prima a tecla do radiocomando.  
 O led n.º 7 indica a memorização do código através de uma intermitência rápida.
  
8. Prima a tecla P para memorizar o código de rádio e mantenha-a premida durante 1 segundo.  
 Todos os leds se acendem e apagam no sentido contrário ao dos ponteiros do relógio e o actuador sai da programação voltando ao estado inicial (leds n.º 8 e n.º 4 acesos).
  
9. Para se certificar do funcionamento correcto proceda à abertura e ao fecho da porta, premindo a tecla do radiocomando.

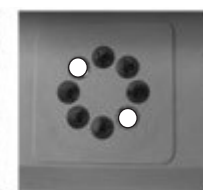
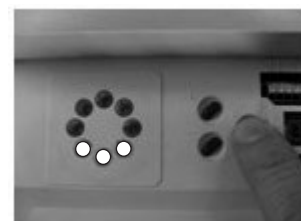
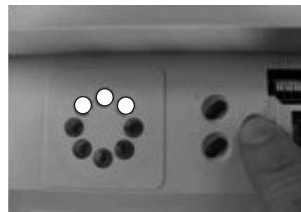
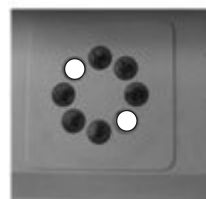

## 7.5 Controlo de funcionamento

### 7.5.1 Marcha de aprendizagem



#### Controlo:

Após a programação rápida e das modificações no menu de programação, precisam ser feitas as seguintes marchas de ensaio (processamento) e controlos.

O sistema de accionamento processa a força motriz máxima necessária durante as duas primeiras marchas após o ajuste das posições do portão.

- Movimento o sistema de accionamento (com portão acoplado), sem interrupção, uma vez da posição portão FECHADO para a posição portão ABERTO e de volta.

O sistema de accionamento determina durante esta marcha de ensaio a força máxima de tracção e compressão e reserva de força, necessária para movimentar o portão.

#### Controlo:

1.		Após pressionar a tecla (+): O portão deve abrir e mover-se para a posição portão ABERTO memorizada.
2.		Após pressionar a tecla (-): O portão deve fechar e mover-se para a posição portão FECHADO memorizada.
3.		Após pressionar a tecla do emissor manual: O sistema de accionamento deve mover o portão na direcção ABERTO e respectivamente na direcção FECHADO.
4.		Após pressionar a tecla do emissor manual enquanto o sistema de accionamento está funcionando: O sistema de accionamento deve parar.
5.		No próximo aperto, o sistema de accionamento vai na direcção contrária.

### 7.5.2 Controlo do sistema automático de desconexão



#### Cuidado!

O sistema automático de desconexão de ABERTO e FECHADO tem de ser ajustado correctamente, para impedir danos pessoais e materiais.

#### Sistema automático de desconexão de ABERTO

Nos sistemas de accionamento para portões com aberturas no batente do portão (diâmetro de abertura > 50 mm):

- Durante a marcha do portão, carregue o centro do bordo inferior com uma massa de 20 kg.

**O portão tem de parar imediatamente.**

#### Sistema automático de desconexão de FECHADO

- Coloque um obstáculo no chão com 50 mm de altura.
- Leve o portão para o obstáculo.

Ao colidir com o obstáculo, o sistema de accionamento tem de parar e fazer a inversão.



#### Observação:

Os ajustes dos parâmetros permanecem memorizados, após uma interrupção da tensão de rede. Somente por meio de reset as forças motrizes ABERTO e FECHADO voltam aos valores do ajuste de fábrica.

## 8. Funções ampliadas do accionamento

### 8.1 Esquema operacional da programação ampliada (Exemplo para nível 2, menu 2)

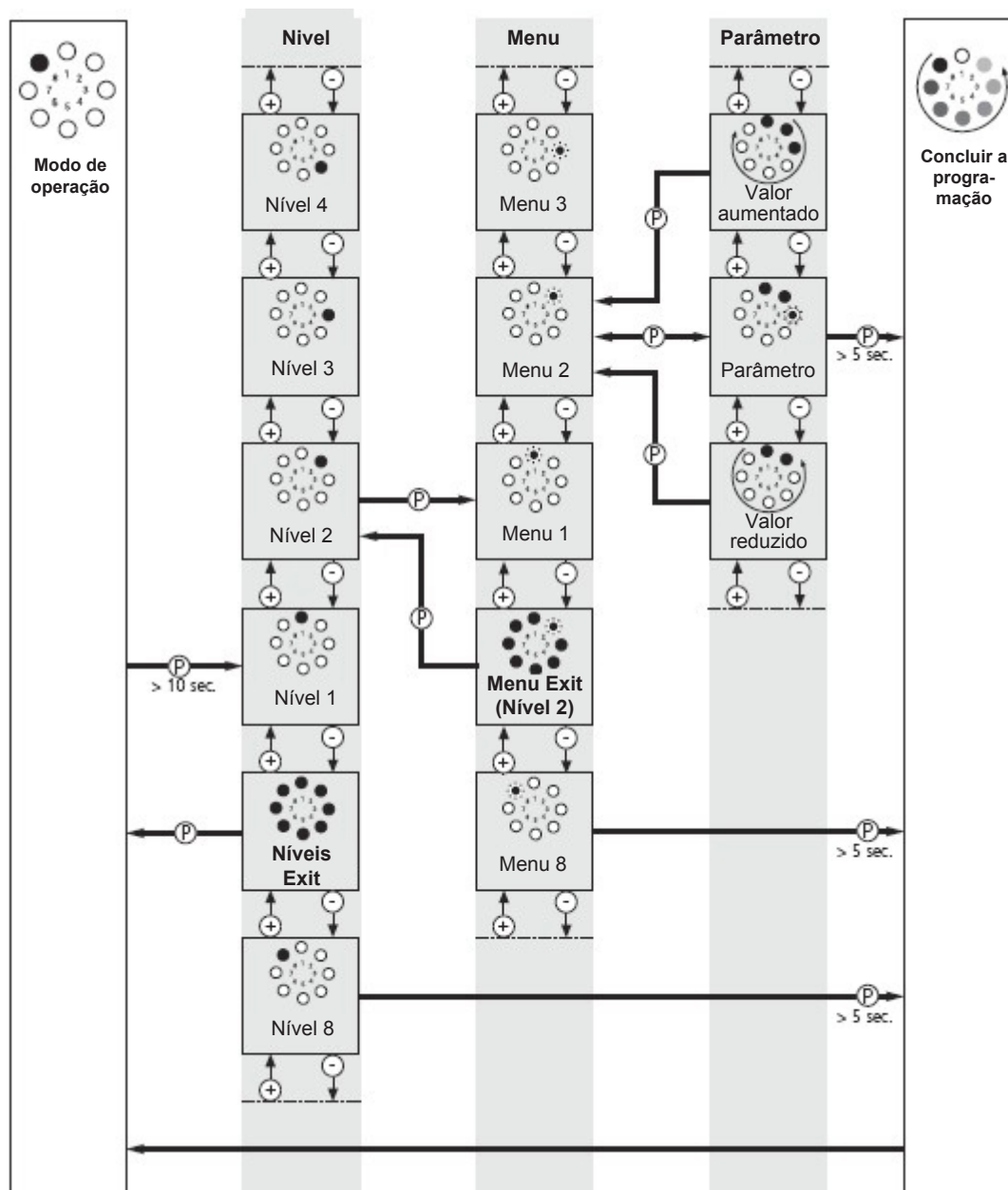

## 8.2 DEFINIÇÃO RÁPIDA DAS FUNÇÕES AVANÇADAS DE PROGRAMAÇÃO



1. Prima o botão (P) por um período > 10 seg.;
2. Aguarde que se apaguem todos os leds, no sentido contrário ao dos ponteiros do relógio, até chegar ao primeiro led Nível (1);

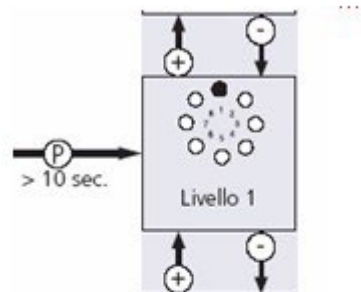

3. Solte o botão (P);
4. Com os botões (+) e (-) escolha o nível desejado e prima o botão (P) para visualizar o Menu do nível (led vermelho intermitente);

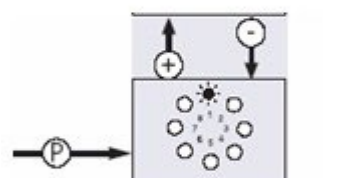

5. Com os botões (+) e (-) escolha o Menu desejado;
6. Prima o botão (P) para entrar no Menu (led vermelho a piscar rapidamente);

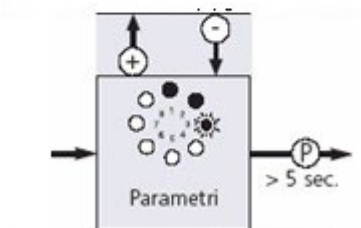

7. Premindo os botões (+) e (-) altere as funções ou os valores, tendo como referência as tabelas indicadas nas instruções;
8. Uma vez escolhido o valor desejado, prima o botão (P) por um período >5 seg. e solte-o quando os leds deixarem de piscar no sentido contrário ao dos ponteiros do relógio.



Termine a programação

### 8.3 Vista de conjunto das funções dos níveis



#### Cuidado!

Nas funções ampliadas do accionamento podem ser modificados importantes ajustes de fábrica. Os parâmetros precisam ser ajustados correctamente, para impedir danos pessoais e materiais.

Nível 1 – Funções básicas																
	1	2	3	4	5	6	7	8	9	10	11	12	13	14	15	16
<b>Menu 3: Posição intermédia ABERTO</b>																
	Ajustar com a tecla (+ / ABERTO) e (- / FECHADO) "Posição intermédia ABERTO" – Função de fecho é possível com fecho automático															
<b>Menu 4: Posição intermédia FECHADO</b>																
	Ajustar com a tecla (+ / ABERTO) e (- / FECHADO)															
<b>Menu 5: Posição de marcha suave ABERTO</b>																
	Ajustar com a tecla (+ / ABERTO) e (- / FECHADO)															
<b>Menu 6: Posição de marcha suave FECHADO</b>																
	Ajustar com a tecla (+ / ABERTO) e (- / FECHADO)															
<b>Menu 7: Saída de relé</b>																
	A7	B7	C7	D7	E7	F7	G7	H7	-	-	-	-	-	-	-	-
<b>Menu 8: Reset</b>																
	No	Si	-	-	-	-	-	-	-	-	-	-	-	-	-	-

#### Atenção!

Após um reset, todos os parâmetros são reiniciados com os ajustes de fábrica.

Para garantir um funcionamento irrepreensível do comando:

- todas as funções desejadas têm de ser programadas de novo,
- o telecomando tem de ser programado,
- o sistema de accionamento tem de ser levado uma vez para a posição de portão ABERTO e FECHADO.



#### Observação:

- Só pode ser utilizada a posição intermédia programada em último lugar.
- Com o fecho automático programado (nível 3 / menu 1) a saída de relé (nível 1 / menu 7) não é programável.



#### Indicação:

Após alterações nos menus 3 a 6 do nível 1, é necessário efectuar uma marcha de aprendizagem nova para o sistema automático de desco-nexão. A marcha de aprendizagem é descrita no ponto 7.5.1.



#### Menu 7: Saída de relé

A7- Sistema de accionamento em curso / lâmpada sinalizadora acende

B7- Sistema de accionamento em curso / lâmpada sinalizadora pisca

C7- Luz durante 3 min.









D7- Impulso de lavagem

E7- Avaria

F7- Dispositivo de segurança contra a abertura por empurrão

G7- Posição de portão FECHADO

H7- Posição de portão ABERTO

Nível 2 – Ajustes de accionamento																
	1	2	3	4	5	6	7	8	9	10	11	12	13	14	15	16
Menu 1: Força de accionamento necessária ABERTO (sensibilidade em níveis*)																
	1	2	3	4	5	6	7	8	9	10	11	12	13	14	15	16
Menu 2: Força de accionamento necessária FECHADO (sensibilidade em níveis*)																
	1	2	3	4	5	6	7	8	9	10	11	12	13	14	15	16
Menu 3: Sistema automático de desconexão ABERTO (sensibilidade em níveis**)																
	Disativata	2	3	4	5	6	7	8	9	10	11	12	13	14	15	16
Menu 4: Sistema automático de desconexão FECHADO (sensibilidade em níveis**)																
	Disativata	2	3	4	5	6	7	8	9	10	11	12	13	14	15	16
Menu 5: Velocidade ABERTO (em níveis)																
	1	2	3	4	5	6	7	8	9	10	11	12	13	14	15	16
Menu 6: Velocidade FECHADO (em níveis)																
	1	2	3	4	5	6	7	8	9	10	11	12	13	14	15	16
Menu 7: Velocidade de marcha suave ABERTO (em níveis)																
	1	2	3	4	5	6	7	8	9	10	11	12	13	14	15	16
Menu 8: Velocidade de marcha suave FECHADO (em níveis)																
	1	2	3	4	5	6	7	8	9	10	11	12	13	14	15	16

\* quanto mais alto for o nível, maior é a velocidade de accionamento.

\*\* quanto mais baixo for o nível, menos sensibilidade tem o sistema automático de desconexão.







### Cuidado!

Para excluir o perigo de lesões, o sistema automático de desconexão (menu 3 e 4) só pode ser programado em DESLIGADO, se uma barreira de luz de passagem ou um dispositivo de segurança no fim de cantos estiverem ligados.



### Indicação:

Após alterações nos menus 5, 6, 7 e 8 no nível 2, é necessário efectuar uma marcha de aprendizagem nova para o sistema automático de desconexão. A marcha de aprendizagem é descrita no ponto 7.5.1.

Nível 3 – Fecho automático																
	1	2	3	4	5	6	7	8	9	10	11	12	13	14	15	16
Menu 1: Fecho automático																
	A1	B1	C1	D1	E1	F1	G1	H1	I1	-	-	-	-	-	-	-
Menu 3: Tempo de abertura do portão (em segundos)																
	2	5	10	15	20	25	30	35	40	50	80	100	120	150	180	255
Menu 4: Tempo de pré-advertência (em segundos)																
	1	2	5	10	15	20	25	30	35	40	45	50	55	60	65	70
Menu 5: Advertência de arranque (em segundos)																
	0	1	2	3	4	5	6	7	-	-	-	-	-	-	-	-





### Observação:

- O fecho automático só pode ser programado se estiver ligada uma barreira de luz ou um dispositivo de segurança no fim de cantos.
- As funções do menu 1 podem ser alteradas à vontade pelos valores temporais nos menus 3, 4 e 5.



















## Menu 1: Fecho automático

	Tempo de abertura do portão	Tempo de préadvertência	Lâmpada sinalizadora	Outras funções
A1	-	-	-	Fecho automático desactivado
B1	15	5	pisca	-
C1	30	5	pisca	-
D1	15	5	pisca	Fecho depois barreira de luz atravessada
E1	30	5	pisca	Fecho depois barreira de luz atravessada
F1	15	5	acende	-
G1	30	5	acende	-
H1	15	5	acende	Fecho depois barreira de luz atravessada
I1	30	5	acende	Fecho depois barreira de luz atravessada

## Nível 4 – Programação de rádio

	
Nível 4 – Programação de rádio	
	LED 7 pisca lentamente -> accionar tecla de emissor manual -> LED 7 pisca rapidamente
Menu 2: Posição intermédia	
	LED 7 pisca lentamente -> accionar tecla de emissor manual -> LED 7 pisca rapidamente



















## Nível 5 – Função especial

	1	2	3	4	5	6	7	8	9	10	11	12	13	14	15	16
																
Menu 1: Entrada de impulso programável – terminal 1/2																
	A1	B1	C1	D1	E1	-	-	-	-	-	-	-	-	-	-	-
Menu 4: Tempo de iluminação (em segundos)																
		5	10	15	20	25	30	35	40	50	80	100	120	150	180	255

## Menu 1: Entrada de impulso programável – terminal 1/2

- A1- Impulso (só contacto de trabalho)
- B1- Sistema automático ligado/desligado (contacto de trabalho)
- C1- Sistema de accionamento pára e faz a inversão (só no sentido de FECHADO – só contacto de ruptura / para a programação da barreira de luz Elvox)
- D1- Impulso ABERTO (lacete indutivo – só contacto de trabalho)
- E1- Paragem (só contacto de ruptura)

## Nível 8 – Ajustes do sistema

	1	2	3	4	5	6	7	8	9	10	11	12	13	14	15	16
																
Menu 1: Barreira de luz																
	A1	B1			-	-	-	-	-	-	-	-	-	-	-	-







## Menu 1: Barreira de luz (só versão com teste)

- A1- Funcionamento sem barreira de luz
- B1- Funcionamento com barreira de luz do sistema (XP020)

## 9. Avisos







### 9.1 Avarias sem indicação de mensagens de avaria





Defeito	Causa	Eliminação
Indicador 8 não brilha.	- Falta tensão.	- Controlar se há tensão de rede disponível. - Controlar conexão eléctrica.
	- Protecção térmica no transformador de rede reagiu.	- Deixar transformador de rede esfriar.
	- Unidade de comando com defeito.	- Deixar controlar o sistema de accionamento.
Nenhuma reacção após geração de impulso.	- Bornes de conexão para tecla "Impulso" pressionados demais, p. ex. através de curto-circuito de cabos ou bornes chatos.	- Desconectar da unidade de comando, a título de teste, a tecla chave ou tecla de pressão interna eventualmente cablada (ponto 6.5): Retirar cabo da tomada XB10, enfiar plug de curto-circuito e procurar defeito de cablagem.
Nenhuma reacção após geração de impulso através de emissor manual.	- Antena modular não conectada.	- Collegare l'antenna ricevente con la centralina (paragrafo 7.1).
	- Codificação do emissor manual não coincide com a codificação do receptor.	- Activar novamente emissor manual (ponto 7.4).
	- Bateria do emissor manual vazia.	- Colocar nova bateria.
	- Emissor manual ou electrónica de comando ou antena modular com defeito.	- Deixar controlar todos os 3 componentes.







Legenda:	
LED (diodo luminoso) apagado	
LED brilha	
LED pisca devagar	
LED pisca ritmicamente	
LED pisca rápido	
Fornecimento de fábrica	
Não é possível	-



## 9.2 Avarias com indicação de mensagem de avaria

Defeito	Causa	Eliminação
Aviso 7 	- Após 120 segundos sem apertar tecla alguma, o modo de programação se conclui automaticamente. - Programação das posições do portão ABERTO e FECHADO sem passar pelo ponto de referência.	
Aviso 8 	- Sensor de ponto de referência avariado.	- Deixar controlar o sistema de accionamento.
Aviso 9 	- Impulsos de sensor de velocidade de rotação inexistentes, sistema de accionamento bloqueado.	- Deixar controlar o sistema de accionamento.
Aviso 10 	- Portão movimenta-se de forma demasiadamente pesada. - Portão bloqueia.	- Fazer o portão movimentar-se.
	- Força motriz máxima ajustada fraca demais.	- Deixar controlar pelo vendedor especializado a força motriz máxima (ponto 8.2 / nível 2 / menu 1+2).
Aviso 11 	- Limitação do tempo de movimento.	- Deixar controlar o sistema de accionamento.
Aviso 15 	- Barreira de luz interrompida ou com defeito.	- Remover obstáculo ou deixar controlar a barreira de luz.
	- Barreira de luz programada, mas não conectada.	- Desactivar ou conectar a barreira de luz.
Aviso 16 	- Sensor de corrente para dispositivo automático de desconexão com defeito.	- Deixar controlar o agregado do motor.

Panne	Cause	Remède
Aviso 26 	- Subtensão, sistema de accionamento sobrecarregado no ajuste da força máxima, nível 16.	- Deixar controlar a alimentação de tensão externa.
Aviso 28 	- Portão movimenta-se de forma demasiadamente pesada ou irregularmente. - Portão bloqueia.	- Controlar movimento do portão e fazer com que o portão se movimente.
	- Dispositivo automático de desconexão ajustado de forma demasiado sensível.	- Deixar controlar pelo vendedor especializado o dispositivo automático de desconexão (ponto 8.2 / nível 2 / menu 3+4).
Aviso 35 	- Electrónica com defeito.	- Deixar controlar o sistema de accionamento.
Aviso 36 	- Plug de curto-circuito retirado, mas tecla Parar não conectada. - Circuito de corrente de repouso interrompido.	- Conectar a tecla Parar ou plug de curto-circuito (ponto 6.5).

Legenda:	
LED (diodo luminoso) apagado	
LED brilha	
LED pisca devagar	
LED pisca ritmicamente	
LED pisca rápido	
Fornecimento de fábrica	
Não é possível	-

Le seguenti informazioni di sicurezza sono parti integranti ed essenziali del prodotto e devono essere consegnate all'utilizzatore. Leggerle attentamente in quanto forniscono importanti indicazioni riguardanti l'installazione, l'uso e la manutenzione. E' necessario conservare il presente modulo e trasmetterlo ad eventuali subentranti nell'uso dell'impianto. L'errata installazione o l'utilizzo improprio del prodotto può essere fonte di grave pericolo.

The following security information is integrant and essential part of the product and must be given to the user. Read it carefully as it gives important suggestions concerning the installation, the use and the maintenance. Keep the present manual in order to be able to transmit it to possible future users of the installation. The erroneous installation or an improper use of the product may cause great danger.

Les suivants renseignements concernant la sécurité sont partie intégrantes et essentielles du produit et doivent être remis à l'utilisateur. Les lire attentivement car il fournissent importantes indications concernant l'installation. Il est nécessaire de conserver le présent manuel et de le transmettre aux autres possibles futurs usagers. L'installation erronée ou l'emploi impropre du produit peut être source de grave danger.

#### IMPORTANTE - INFORMAZIONI DI SICUREZZA

- L'installazione deve essere eseguita da personale professionalmente competente e in osservanza della legislazione nazionale ed europea vigente.
- Dopo aver tolto l'imballo assicurarsi dell'integrità dell'apparecchio, in caso di dubbio rivolgersi a personale qualificato.
- I materiali d'imballaggio (cartone, sacchetti di plastica, graffe, polistirolo ecc.) devono essere smaltiti negli appositi contenitori e non devono essere dispersi nell'ambiente soprattutto non devono essere lasciati alla portata dei bambini.
- La posa in opera, i collegamenti elettrici e le regolazioni devono essere effettuati a "Regola d'arte", assicurarsi che i dati di targa siano rispondenti a quelli della rete elettrica e accertare che la sezione dei cavi di collegamento sia idonea ai carichi applicati, in caso di dubbio rivolgersi a personale qualificato.
- Non installare il prodotto in ambienti a pericolo di esplosione o disturbati da campi elettromagnetici. La presenza di gas o fumi infiammabili costituisce un grave pericolo per la sicurezza.
- Prevedere sulla rete di alimentazione una protezione per extratensioni, un interruttore/sezionatore e/o differenziale adeguati al prodotto e in conformità alle normative vigenti.
- Indicare chiaramente sul cancello, porta, seranda o barriera che sono comandati a distanza mediante apposito cartello.
- La ELVOX s.p.a. non può essere considerata responsabile per eventuali danni causati qualora vengano installati dei dispositivi e/o componenti incompatibili ai fini dell'integrità del prodotto, della sicurezza e del funzionamento.
- L'apparecchio dovrà essere destinato al solo uso per il quale è stato concepito, ogni altra applicazione è da considerarsi impropria e quindi pericolosa.
- Prima d'effettuare una qualsiasi operazione di pulizia o di manutenzione, disinserire l'apparecchio dalla rete, staccando la spina, o spegnendo l'interruttore dell'impianto. Per la riparazione o sostituzione delle parti danneggiate, dovranno essere utilizzati esclusivamente ricambi originali.
- L'installatore deve fornire tutte le informazioni relative al funzionamento, alla manutenzione e dell'utilizzo delle singole parti componenti e del sistema nella sua globalità.

#### IMPORTANT - SECURITY INFORMATION

- The installation must be carried out by professional technicians and according to the national and european safety regulations in force.
- After removing the packing check the integrity of the appliance. If in doubt contact qualified personnel.
- The packaging (carton, plastic bags, clips, polystyrene etc.) must be disposed of properly in the appropriate containers. It must not be left within the reach of children.
- The installation, the electrical connections and the adjustments must be carried out perfectly; check that the data on the specification plate correspond to those of the mains supply and that the connection cable cross-section is suitable for the applied loads, in case of doubt contact qualified personnel.
- Do not install the appliance in premises with danger of explosion or disturbed by magnetic fields. The presence of gasses or inflammable fumes is a great danger for the safety.
- A proper protection against extratensions should be install on the supply voltage network, i.e. a switch/sectioner and/or differential suitable for the product and according to the regulations in force.
- The gate, door, rolling shutter or barrier should bear a plate indicating that they are remotely controlled.
- ELVOX S.p.A. will not accept liability for any damage caused by the incorrect installation of devices and/or components not suitable for the integrity, the safety and the operation of the unit.
- The product must only be used for the purposes for which it was designed. Any other use is incorrect and hence dangerous.
- Before carrying out any cleaning or maintenance work, disconnect the unit from the mains supply, either by unplugging the power cord or by switching off the mains supply.
- Any repair work or replacement of damaged parts must be carried out by qualified personnel using original parts and components.
- The installer must supply all the information concerning the operation, the maintenance and the use of the single components and the whole system.

#### IMPORTANT - RENSEIGNEMENTS POUR LA SÉCURITÉ

- L'installation doit être effectuée par personnel professionnellement compétent et conforme à la législation nationale et européenne en vigueur.
- Après avoir enlevé l'emballage s'assurer de l'intégrité de l'appareil, en cas de doute s'adresser à personnel qualifié.
- Les éléments de l'emballage (boîtes, sachets de plastique, agrafes, polistyrène etc.) doivent être recyclés ou éliminés en utilisant les poubelles prévues à cet effet pour ramassage différencié, surtout ils ne doivent pas être laissés à la portée des enfants.
- La mise en ouvre, les raccordements électriques et les réglages doivent être effectués parfaitement; les données de la plaque doivent être conformes à celles du réseau électrique et s'assurer que la section des câbles de raccordement soit adaptée aux charges appliqués; en cas de doute s'adresser à personnel qualifié.
- Ne pas installer le produit dans des environnements avec danger d'explosion ou dérangés par des champs électromagnétiques. La présence de gas ou fumées inflammables constitue un grave danger pour la sécurité.
- Prévoir sur le réseau d'alimentation une protection contre les extratensions: un interrupteur/sectionneur et/ou différentiel appropriés au produit et en conformité aux normes en vigueur.
- Indiquer clairement sur la grille, porte, rideau roulant et barrière (au moyen d'une plaque appropriée) qu'ils sont gérés à distance.
- ELVOX S.p.A. décline toute responsabilité pour des dommages éventuels à cause d'une installation des dispositifs et/ou composants incompatibles aux buts de l'intégrité du produit, de la sécurité et du fonctionnement.
- L'appareil devra être destiné qu'à l'usage pour lequel il a été conçu, toute autre application doit être considérée comme impropre et donc dangereuse.
- Avant d'effectuer une opération de nettoyage ou d'entretien quelconque, débrancher l'appareil en enlevant la fiche ou en déclenchant l'interrupteur de l'installation.
- Pour la réparation ou remplacement des parties endommagées, il faut utiliser seulement pièces détachées et composants d'origine.
- L'installateur doit fournir tous les renseignements relatifs au fonctionnement, à l'entretien et à l'emploi des composants individuels et du système dans sa globalité.

#### DICHIARAZIONE DI INCORPORAZIONE DI QUASI-MACCHINE (DIRETTIVA 2006/42/CE)

##### ELVOX S.p.A.

**Indirizzo:** Via Pontarola 14/A – 35011 Campodarsego (Pd)

**Dichiara che:** L'articolo ESK6

è costruito per essere incorporato in una macchina o per essere assemblato con altri macchinari per costruire una macchina ai sensi della Direttiva 2006/42/CE è conforme ai requisiti essenziali di sicurezza delle seguenti altre direttive CEE 2006/95/CE Direttiva Bassa Tensione 2004/108/CE Direttiva Compatibilità Elettromagnetica

Inoltre dichiara che non è consentito mettere in servizio il macchinario fino a che la macchina in cui sarà incorporato o di cui diverrà componente non sia stata identificata e ne sia stata dichiarata la conformità alle condizioni della Direttiva 2006/42/CEE e successive modifiche.

Campodarsego, 23/06/2010  
L'Amministratore Delegato

#### DECLARATION OF INCORPORATION OF PARTLY COMPLETED MACHINERY (DIRECTIVE 2006/42/EC)

##### ELVOX S.p.A.

**Address:** Via Pontarola 14/A – 35011 Campodarsego (Pd)

**Declares that:** The article ESK6

is constructed to be incorporated in a machine or to be assembled with other machinery to construct a machine under the provisions of Directive 2006/42/EC conforms to the essential safety requirements of the other following EEC directives 2006/95/EC Low Voltage Directive 2004/108/EC Electromagnetic Compatibility Directive

Furthermore it declares that the machinery covered by this Declaration must not be put into service until the machine into which it is to be incorporated or of which it is a component has been found and declared to be in conformity with the provisions of Directive 2006/42/EEC and subsequent amendments.

Campodarsego, 23/06/2010  
The Managing Director

#### DÉCLARATION D'INCORPORATION DE QUASI-MACHINES (DIRETTIVA 2006/42/CE)

##### La société ELVOX S.p.A.

**Adresse :** Via Pontarola 14/A – 35011 Campodarsego (Pd)

**Déclare que :** L'article ESK6

a été fabriqué pour être incorporé dans une machine ou pour être assemblé à d'autres équipements en vue de réaliser une machine conforme à la Directive 2006/42/CE est conforme aux dispositions de sécurité des directives CEE suivantes : 2006/95/CE Directive Basse Tension 2004/108/CE Directive Compatibilité Électromagnétique

En outre, elle déclare qu'il est interdit de mettre la machine en service tant que la machine dans laquelle elle sera incorporée ou de laquelle elle deviendra un composant, n'aura été identifiée et n'aura été déclarée conforme aux dispositions de la Directive 2006/42/CEE et modifications suivantes.

Campodarsego, 23/06/2010  
L'Administrateur Délégué

## GARANZIA DI PRODOTTO ELVOX - CONDIZIONI GENERALI

- 1) La suddetta garanzia convenzionale lascia impregiudicati i diritti del consumatore derivanti dalla applicazione della Direttiva Comunitaria 99/44/CE riguardo la garanzia legale ed è regolata dal D.L. n. 24 del 02.02.2002 pubblicato sulla G.U. n. 57 del 08.05.2002.
- 2) La garanzia dei prodotti ELVOX è di 24 mesi dalla data di acquisto e comprende la riparazione con sostituzione gratuita delle parti che presentano difetti o vizi di materiale. La denuncia di vizio del prodotto deve essere comunicata entro 2 mesi dal rilevamento del vizio, quindi per un periodo totale di copertura di 26 mesi.
- 3) La ELVOX Costruzioni Elettroniche S.p.A. presta la garanzia presso i Centri di Assistenza, per i prodotti presentati o inviati completamente al certificato di garanzia compilato in tutte le sue parti con il documento fiscale comprovante la data di acquisto. La riparazione o la sostituzione dei pezzi durante il periodo di garanzia non comporta un prolungamento del termine di scadenza della garanzia stessa.
- 4) Il certificato di garanzia non copre:
  - apparecchi non funzionanti a causa di una non corretta riparazione effettuata da soggetti non qualificati;
  - le parti che presentano normale usura;
  - cattivo o diverso uso non conforme a quello indicato nel manuale di istruzione e negli schemi allegati alle apparecchiature;
  - tutti i danni causati da calamità naturali, manomissioni, alimentazione non corretta;
  - i vizi di funzionamento derivanti da una non corretta installazione non effettuata conformemente alla documentazione fornita dalla ELVOX S.p.A.
  - i danni causati dal trasporto da parte di soggetti terzi non sotto la responsabilità della ELVOX S.p.A.

### Assistenza tecnica post garanzia

Gli interventi fuori garanzia comprendono le spese relative ai ricambi, alla manodopera ed al diritto fisso di chiamata.

## GUARANTEE FOR THE ELVOX PRODUCTS – GENERAL CONDITIONS

- 1) The above mentioned conventional guarantee leaves unprejudiced the consumer rights arising from the application of the EU Directive 99/44/CE as far as the legal guarantee is concerned and is ruled by the D.L. n. 24 dated 02.02.2002 published in G.U. 57 dated 18.05.2002.
- 2) The ELVOX product guarantee lasts 24 months from the purchase date and includes the repair with free replacement of parts with defects or material vices. The product vice denunciation must be communicated within 2 months from the vice detection, therefore for a total coverage period of 26 months.
- 3) Elvox Costruzioni Elettroniche S.p.A. allows the guarantee by the Assistance Centres, for products presented or sent complete with the guarantee document filled in in all its parts and accompanied by the fiscal bill proving the purchase date.
- 4) The guarantee certificate does not cover:
  - appliances not working because of a not correct repair carried out by not qualified personnel.
  - parts presenting normal wear and tear.
  - bad or different use of the appliance not in accordance with the instruction manual and the wiring diagrams enclosed with the appliances;
  - all damages caused by natural calamities, tampering, and incorrect supply voltage;
  - operation vices arising from an incorrect installation carried out disregarding the documentation supplied by Elvox S.p.a.
  - damages caused during the transportation by third parties not under the Elvox S.p.A. liability.

### Post guarantee technical assistance

The assistance out of guarantee includes the costs concerning the spare parts, manpower and fees for the call.

## GARANTIE DE PRODUIT ELVOX – CONDITIONS GÉNÉRALES

- 1) La susdite garantie conventionnelle laisse en suspens les droits du consommateur dérivant de l'application de la Directive Communautaire 99/44/CE concernant la garantie légale et est réglée par le D.L. n. 24 de 02.02.2002 publié sur la G.U. n. 57 de 08.05.2002.
- 2) La garantie des produits ELVOX est de 24 mois à partir de la date d'achat et comprend la réparation avec substitution gratuite des parties qui présentent des défauts ou vices de matériel. La dénonciation de vice du produit doit être communiquée entre 2 mois de la détection du vice, donc pour une période totale de couverture de 26 mois.
- 3) ELVOX Costruzioni Elettroniche S.p.A. offre la garantie chez les Centres d'Assistance, pour les produits présentés ou envoyés complets avec la certification de garantie compilée dans toutes ses parties avec le document fiscal prouvant la date d'achat. La réparation ou substitution des pièces durant la période de garantie ne comporte pas un prolongement du terme d'expiration de la même garantie.
- 4) La certification de garantie ne couvre pas :
  - appareils qui ne fonctionnent pas à cause d'une non correcte réparation effectuée par personne non qualifiées ;
  - les parties qui présentent normale usure ;
  - mauvais ou différent emploi non conforme à celui indiqué dans le manuel d'instructions joint aux appareils ;
  - tous les dommages causés par calamités naturelles, violations, alimentation non correcte ;
  - les vices de fonctionnement dérivant d'une non correcte installation non effectuée conformément à la documentation fournie par ELVOX S.p.A.
  - les dommages causés pendant le transport par sujets tiers non sous la responsabilité de ELVOX S.p.A.

### Assistance technique post garantie

Les interventions hors de garantie comprennent les frais relatifs aux pièces de rechange, à la main-d'œuvre et au droit fixe d'appel.

Die folgenden Informationen sind wesentliche Teile des Produkts und müssen dem Benutzer übergeben werden. Bitte lesen Sie sie aufmerksam, weil Sie wichtige Informationen in Bezug auf die Installation, die Anwendung und die Wartung ausrüsten. Es ist notwendig diese Unterlage bewahren und zu anderen eventuellen Benutzern der Installation zu übermitteln. Eine falsche Installation und eine ungeeignete Anwendung kann gefährlich sein.

#### WICHTIGE SICHERHEITSINFORMATIONEN

- Die Installation muß von Fachpersonal und nach den gültigen nationalen und europäischen Richtlinien durchgeführt werden.
- Nach Entfernung der Verpackung versichern Sie sich über die Unversehrtheit des Apparats. Im Zweifelsfall wenden Sie sich an Fachpersonal.
- Die Verpackungsteile (Plastikbeutel - Karton - Klammern - Polystyrol usw.) sind in den dazu bestimmten Behältern zu entsorgen und dürfen nicht die Umwelt verschmutzen und nicht in der Reichweite von Kindern gelassen werden.
- Das Installieren, die elektrischen Anschlüsse und die Einstellungen dürfen vollkommen durchgeführt werden; versichern Sie sich dass die Daten entsprechen den des elektrischen Netzes und kontrollieren Sie dass der Querschnitt der Anschlusskabel den gegebenen Ladungen geeignet ist. Im Zweifelsfall wenden Sie sich an Fachpersonal.
- Einbauen Sie nicht das Erzeugnis in Umstände mit Gefahr von Explosion oder gestört mit elektromagnetischen Feldern. Die Anwesenheit von entzündbaren Gasen oder Rauchen sind eine Gefahr für die Sicherheit.
- Bei dem Spannungsversorgungsnetz muß einen Schutz gegen Extraspannungen vorgesehen werden: einen dem Produkt geeigneten Schalter/Trennschalter und/oder Differential und konform den gültigen Richtlinien.
- Tor, Tür, Rolläden oder der Schranke müssen ein Schield erhalten, das über eine Fernsteuerung benachrichtigt.
- ELVOX S.p.A kann nicht haftbar gemacht werden für eventuelle Schäden verursacht von der Installation von ungeeigneten Vorrichtungen und/oder Komponenten, die können die Integrität, Sicherheit und Betrieb des Produkts beschädigen.
- Das Gerät ist nur für seinen geplanten Gebrauch bestimmt, jede andere Anwendung ist als ungeeignet und daher gefährlich zu betrachten.
- Vor Ausführung sämtlicher Reinigungs- oder Wartungsarbeiten, abschalten Sie das Gerät vom Spannungsnetz durch Ausschalten den Stecker oder den Schalter der Installation. Für die Reparatur oder Ersetzung von beschädigten Teilen, nur Originalersatzteile verwenden.
- Der Installateur muß alle Informationen in Bezug auf den Betrieb, die Wartung und den Gebrauch von den einzelnen Komponenten und dem System in seine Totalität austatten.

#### EINBAUERKLÄRUNG FÜR UNVOL- LSTÄNDIGE MASCHINEN (RICHTLINIE 2006/42/EG)

ELVOX S.p.A. Anschrift:  
Via Pontarola 14/A - 35011 Campodarsego (Pd)  
erklärt hiermit, dass: der Artikel ESK6 für den Einbau in eine Maschine oder für den Zusammenbau mit anderen Maschinenteilen ausgelegt ist, um eine Maschine nach Maßgabe der Richtlinie 2006/42/EG zu erhalten und erfüllt die grundlegenden Anforderungen an Sicherheit und Gesundheitsschutz der folgenden anderen EU-Richtlinien  
2006/95/EG Niederspannungsrichtlinie  
2004/108/EG EMV-Richtlinie

Der Hersteller erklärt außerdem, dass die unvollständige Maschine erst dann in Betrieb genommen werden darf, wenn die Maschine, in die sie eingebaut werden soll bzw. deren Bestandteil sie werden soll, gekennzeichnet und für mit den Bestimmungen der Maschinenrichtlinie 2006/42/EG i.d.g.F. konform erklärt wurde.

Campodarsego, 23/06/2010  
Der Geschäftsführer

Las informaciones siguientes de seguridad son partes integrantes y esenciales del producto y deben ser consignadas al utilizador. leerlas atentamente pues dan importantes indicaciones concernientes la instalación, el uso y la manutención. La instalación errónea o el uso impropio del producto puede ser fuente de grave peligro.

#### IMPORTANTE - INFORMACIONES CONCERNIENTES LA SEGURIDAD

- La instalación debe ser efectuada por personal profesionalmente competente y conforme a la legislación nacional y europea en vigor.
- Después de quitar el embalaje asegurarse de la integridad del aparato; en caso de duda contactar personal calificado.
- Los elementos del embalaje (cartón, bolsos en plástico, grasas, poliestireol etc. ) deben ser reciclados en contenedores apropiados, no deben ser dejados en el ambiente y sobre todo no deben ser dejados al alcance de los niños.
- La puesta en obra, el conexionado eléctrico y las regulaciones deben ser hechas correctamente, controlando que los datos de la placa sean conformes a los de la red eléctrica y verificar que la sección de los cables del conexionado sea adecuada a las cargas aplicadas; en caso de duda contactar personal calificado.
- No instalar el producto en ambientes con peligro de explosión o estorbados por campos electromagnéticos. La presencia de gases o humos inflamables constituye un grave peligro para la seguridad.
- Prever en la red de alimentación una protección para las extratensiones: un interruptor/aislador y/o diferencial adecuados al producto y en conformidad con las normas en vigor.
- Indicar claramente con una tarjeta colocada en la reja, puerta, cierre enrollable o barrera que la automatización es mandada a distancia.
- ELVOX S.p.A declina toda responsabilidad por eventuales daños causados por la instalación errónea de dispositivos y/o componentes y que no son conformes a los fines de la integridad, seguridad y funcionamiento del producto.
- El aparato debe ser destinado solamente para el uso por el cual fue concebido, toda otra aplicación debe ser considerada impropia y por tanto peligrosa.
- Antes de efectuar cualquier operación de limpieza o de manutención, desconectar el aparato de la red, sacando el enchufe o apagando el interruptor de la instalación. Para la reparación o sustitución de las partes dañadas, tendrán que utilizarse exclusivamente repuestos originales.
- El instalador debe proveer todas las informaciones relativas al funcionamiento, a la manutención y al uso de las partes individuales y del sistema en su totalidad.

#### DECLARACIÓN DE INCORPORACIÓN DE CUASI MÁQUINAS (DIRECTIVA 2006/42/CE)

ELVOX S.p.A.  
Dirección: Via Pontarola, 14/a - 35011 Campodarsego (PD)  
Declara que: El artículo ESK6 está fabricado para ser incorporado en una máquina o para ser ensamblado con otras máquinas para construir una máquina según la Directiva 2006/42/CE es conforme a los requisitos esenciales de seguridad de las siguientes directivas CEE  
2006/95/CE Directiva Baja Tensión  
2004/108/CE Directiva Compatibilidad Electromagnética

Además, declara que no está permitido poner en marcha la cuasi máquina hasta que se identifique la máquina en que vaya a ser incorporado o de la que vaya a ser componente y se declare su conformidad a las condiciones de la Directiva 2006/42/CE y modificaciones posteriores.

Campodarsego, 23/06/2010  
El Consejero Delegado

As seguintes informações de segurança são parte integrante e essenciais do produto e devem ser entregues ao utilizador o qual as deve ler atentamente na medida em que lhe fornecem importantes indicações sobre a instalação, uso e manutención. É necessário conservar estas informações e, se necessário, transmiti-las a futuros utilizadores da instalação. Uma instalação errada ou uma utilização imprópria do produto pode ser muito perigosa.

#### IMPORTANTE - INFORMAÇÕES DE SEGURANÇA

- A instalação deve ser efectuada por pessoal profissionalmente competente e conforme as normas nacionais e europeias em vigor.
- Após abrir a embalagem verificar a integridade do aparelho e, no caso de dúvida, consultar um instalador ou pessoal especializado.
- Os elementos da embalagem (cartões, sacos de plástico, agrafos, esferovite, etc.) devem ser reciclados em contentores de lixo apropriados, não devem ficar dispersos no ambiente e, sobretudo, não devem ficar ao alcance de crianças.
- A instalação, as ligações e as regulações devem ser efectuadas de acordo com as boas regras da arte; verificar se os dados da placa estão de acordo com os da rede eléctrica e se as secções dos cabos de ligação estão adaptados às cargas aplicadas; em caso de dúvida consultar pessoal qualificado.
- Não instalar o produto em ambientes com perigo de explosão ou sujeitos a campos electromagnéticos. A presença de gases ou fumos inflamáveis constitui um grave perigo para a segurança.
- Prever, na rede de alimentação, uma protecção para extratensões; um interruptor/seccionador e/ou diferencial adequado para o produto e em conformidade com as normas em vigor.
- Indicar claramente (através de uma placa) no portão, porta, persiana ou barreira que são comandados à distância.
- A ELVOX S.p.a. não pode ser considerada responsável por eventuais danos causados pela instalação incorrecta dos dispositivos e/ou por componentes incompatíveis com a integridade, segurança e funcionamento do produto.
- O aparelho destina-se apenas ao uso para o qual foi concebido pelo que qualquer outra aplicação é de considerar imprópria e, portanto, perigosa.
- Antes de efectuar qualquer operação de limpeza ou manutención desligar o aparelho da rede eléctrica, retirando a ficha ou desligando o interruptor da instalação.
- Para a reparação ou substituição de partes danificadas, utilizar apenas peças de substituição originais.
- O instalador deve fornecer todas as informações referentes ao funcionamento, manutención e utilização dos componentes individuais e do sistema na sua globalidade.

#### DECLARAÇÃO DE INCORPORAÇÃO DE QUASE-MAQUINAS (DIRECTIVA 2006/42/CE)

ELVOX S.p.A.  
Endereço: Via Pontarola 14/A - 35011 Campodarsego (Pd)  
Declara que: O artigo ESK6 foi fabricado para ser incorporado numa máquina ou para ser montado com outro equipamento de forma a construir uma máquina nos termos da Directiva 2006/42/CE  
Está em conformidade com os requisitos essenciais de segurança das outras directivas CEE seguintes  
2006/95/CE Directiva de Baixa Tensão  
2004/108/CE Directiva de Compatibilidade Electromagnética

Declara ainda que não é permitido pôr o equipamento a funcionar enquanto a máquina em que for incorporado ou da qual se tornar componente não tiver sido identificada e não tiver sido declarada a sua conformidade com as condições da Directiva 2006/42/CE e subsequentes alterações.

Campodarsego, 23/06/2010  
O Administrador Delegado

## GARANTIE FÜR DIE ELVOX-PRODUKTE – GEMEINSAME BEDINGUNGEN

- 1) Die obengennante konventionelle Garantie lässt unbeschadet die Verbrauchergerechte auskommend von der Anwendung der EU Richtlinie n. 99/44/CE in Bezug auf die legale Garantie und ist vom D.L. n. 24, 02.02.2002 veröffentlicht in G.U. n. 57 von 08.05.2002.
- 2) Die Garantie für die ELVOX-Produkte dauert 24 Monate vom Kaufdatum und umfasst die Reparatur mit freier Ersetzung der Teile mit Defekten oder Materialfehler.  
Die Fehleranzeige des Produkts muss innerhalb 2 Monate von der Fehlermeldung kommuniziert, dann für eine totale Periode-deckung von 26 Monaten.  
Die Reparatur oder Ersetzung der Teile während der Garantieperiode verbindet sich nicht mit der Terminverlängerung derselben Garantieverfallzeit.
- 3) ELVOX COSTRUZIONI ELETTRONICHE S.p.A. bedient die Garantie bei den Dienstkundenstellen, für die Produkte, die vorgelegt oder gesendet komplett mit dem Garantiedokument sind und die ausgefüllt in allen ihren Teilen sind, mit dem fiskalischen Beleg, der das Kaufdatum beweist.
- 4) Die Garantiebescheinigung bedeckt nicht:
  - Geräte, die funktioniert nicht wegen einer nicht korrekten Reparatur, die nicht durch qualifizierte Personelle durchgeführt ist.
  - Teile mit normalem Verschleiß
  - schlechte oder verschiedene Verwendung, von der in den Anleitungen und bei den beigelegten Schaltplänen der Geräte angezeigt wird.
  - Alle Schaden verursacht von Naturalunheil, Handerbrechen, oder nicht richtiger Versorgungsspannung.
  - Betriebsfehler wegen einer nicht vollkommenen Installation, die nicht gemäß den mitgelieferten Elvox-Dokumenten durchgeführt war.
  - Schaden verursacht während des Transports bei Agenten nicht unter der ELVOX S.p.A – Verantwortung.

## GARANTÍA DE PRODUCTO ELVOX – CONDICIONES GENERALES

- 1) La sobredicha garantía convencional deja imprejudicados los derechos del consumidor derivantes de la aplicación de la Directiva Comunitaria 99/44/CE en lo que concierne la garantía legal y es regulada por el D.L. n. 24 del 02.02.2002 publicado en la G.U. n. 57 del 08.05.2002.
- 2) La garantía de los productos Elvox dura 24 meses desde la fecha de adquisición y comprende la reparación con sustitución gratuita de las partes que presentan defectos o vicios de material.  
La denuncia de vicio del producto debe ser efectuada dentro de 2 meses desde la detección del vicio, por lo tanto por un periodo total de 26 meses.
- 3) La ELVOX Costruzioni Elettroniche Spa ofrece la garantía en los Centros de Asistencia, para los productos presentados o enviados completos juntamente con el certificado de garantía compilado en todas sus partes con el documento fiscal comprobante la fecha de adquisición.  
La reparación o la sustitución de piezas durante el periodo de garantía no comporta una prolongación del término de expiración de la misma garantía.
- 4) El certificado de garantía no cubre:
  - aparatos no funcionantes a causa de una no correcta reparación efectuada por personas no calificadas.
  - las partes que presentan una normal usura;
  - malo o diverso uso no conforme a aquel indicado en el manual de instrucciones y en los esquemas adjuntos a los aparatos;
  - todos los daños causados por calamidades naturales, manomisiones, alimentación no correcta;
  - los vicios de funcionamiento derivantes de una no correcta instalación no efectuada conformemente a la documentación suministrada por ELVOX S.p.A.
  - los daños causados durante el transporte por parte de personas terceras no bajo la responsabilidad de ELVOX S.p.A .

## GARANTIA DE PRODUCTO ELVOX – CONDIÇÕES GERAIS

- 1) A sobredita garantia convencional deixa não prejudicados os direitos do consumidor derivantes da aplicação da Directiva Comunitaria 99/44/CE no que diz respeito à garantia legal e é regulada pelo D.L. n. 24 do 02.02.2002 publicado na G.U. n. 57 do 08.05.2002.
- 2) A garantia dos produtos ELVOX é de 24 meses da data de compra e compreende a reparação com substituição gratuita das partes que têm defeitos o vícios de material.  
A denúncia do vício do produto deve ser comunicada entro 2 meses da deteção do vício, portanto por un período total de cobertura de 26 meses.
- 3) A ELVOX Costruzioni Elettroniche S.p.A. oferece a garantia nos Centros de Assistência, pelos produtos apresentados ou enviados completos juntamente com o certificado de garantia compilado em todas as suas partes com o documento fiscal comprovante a data de aquisição. A reparação o a substituição das peças durante o periodo de garantia não comporta nenhum prolongamento do término de vencimento da mesma garantia.
- 4) O certificado de garantia não cobre:
  - aparelhos não funcionantes a causa de uma não correcta reparação efectuada por pessoas não qualificadas;
  - as partes que apresentam normal usura;
  - mau ou diverso uso não conforme àquele indicado no manual de instruções e nos esquemas juntados aos aparelhos.
  - todos os danos causados por calamidades naturais, manomissões, alimentação não correcta;
  - os vícios de funcionamento derivantes de uma não correcta instalação não efectuada conformemente à documentação fornecida pela ELVOX S.p.A.
  - os danos causados durante o transporte por parte de pessoas terceiras não sob a responsabilidade da ELVOX S.p.A

---

NOTE:



CERTIFICATO DI GARANZIA AUTOMAZIONI (Allegare al prodotto in caso di riparazione in garanzia)  
AUTOMATION GUARANTEE CERTIFICATE (Enclose with the product in case of repair under guarantee)  
CERTIFICATION DE GARANTIE AUTOMATISMES (À ajouter au produit en cas de réparation en garantie)  
GARANTIEZERTIFIZIERUNG DES AUTOMATISCHEN ANTRIEBS (Zum Beilegen mit dem Produkt falls einer Garantiereparatur)  
CERTIFICADO DE GARANTÍA AUTOMATIZACIONES (Adjuntar al producto en caso de reparación en garantía)  
CERTIFICADO DE GARANTIA AUTOMATIZAÇÕES (Juntar ao produto no caso de reparação em garantia)

ARTICOLO / MATRICOLA, ARTICLE / REGISTRATION NUMBER  
ARTICLE / NUMÉRO MATRICULE, ARTIKEL / REGISTRIERNUMMER  
ARTÍCULO/NUMERO DE ARTÍCULO, ARTIGO / NUMERO DE ARTIGO

COLLAUDATORE, INSPECTOR  
TESTEUR, PRÜFER  
ENSAYADOR, VERIFICADOR

INDIRIZZO DELL'UTILIZZATORE, ADDRESS OF USER, ADRESSE DE L'USAGER  
ADRESSE DES BENUTZERS, DIRECCIÓN DEL USUARIO, DIREÇÃO DO UTENTE:

Cognome, Surname, Prénom, Familienname, Apellido, Apellido.....

Nome, Name, Nom, Name, Nombre, Nome, .....

Via, Address, Adresse, Adresse, Dirección, Direção.....

CAP.....CITTA', CITY, VILLE, CITTA'..... PR.....

Tél, Tel.....

TIMBRO DELL'INSTALLATORE, INSTALLER STAMP  
TIMBRE DE L'INSTALLATEUR, STEMPEL DES INSTALLATEURS  
TIMBRE DEL INSTALADOR, TIMBRE DO INSTALADOR

DATA DI INSTALLAZIONE, DATE OF INSTALLATION  
DATE DE L'INSTALLATION, DATUM DER INSTALLATION  
FECHA DE LA INSTALACIÓN, DATA DA INSTALAÇÃO

Riproduzione vietata anche parziale. La società ELVOX s.p.a. tutela i diritti sui propri elaborati a termine di Legge.

Reproduction forbidden, even partial. ELVOX S.P.A. guards its own rights according to the law.

Réproduction défendu, même partiale. La Société ELVOX S.P.A. defende ses droits selon la loi.

Nachdruck (auch partial) verboten. Alle Rechte an der technischen Dokumentation bei der ELVOX AG.

Reproducción prohibida también parcial. ELVOX s.p.a. defiende sus derechos según la ley.

Reprodução proibida mesmo parcial. A sociedade ELVOX s.p.a. tem os seus direitos registados e protegidos nos termos da Lei.



**EDVAX**

 **VIMAR** group

Vimar SpA: Viale Vicenza, 14  
36063 Marostica VI - Italy  
Tel. +39 0424 488 600 - Fax (Italia) 0424 488 188   
Fax (Export) 0424 488 709  
[www.vimar.com](http://www.vimar.com)



S6I.EN0.500 01 13 12  
VIMAR - Marostica - Italy